

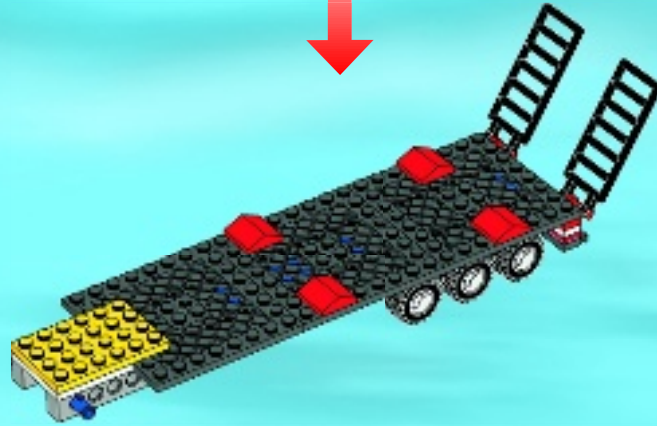

# CITY

4430







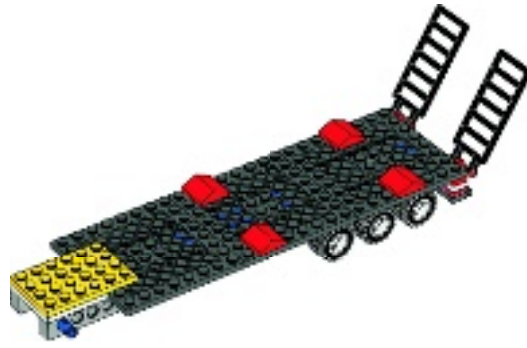

1



2

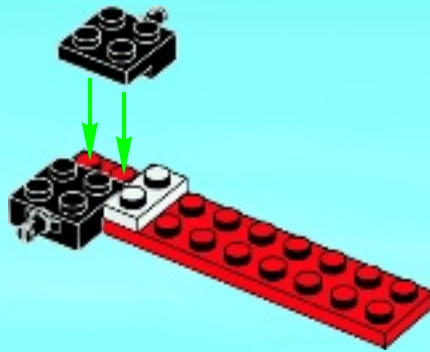

3



4



1

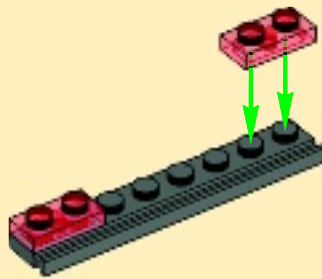

2

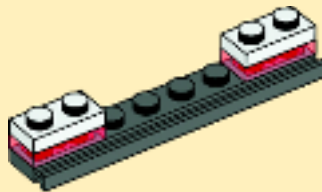

3

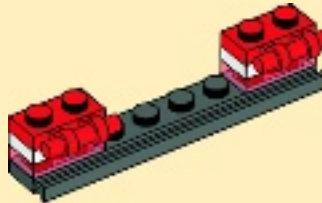

5







1

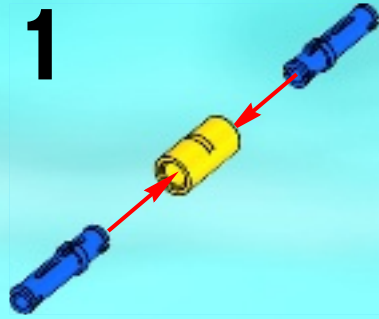

2

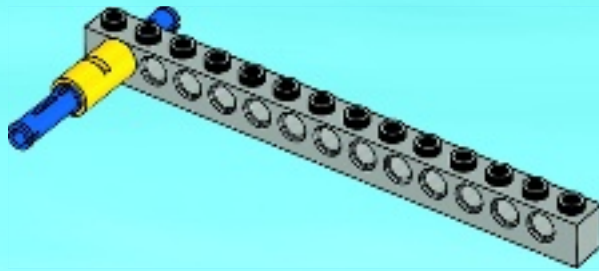

3

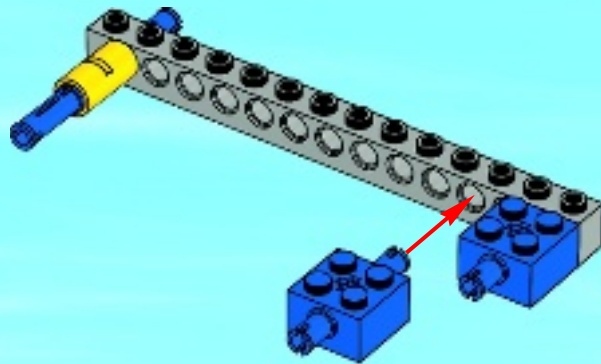

4

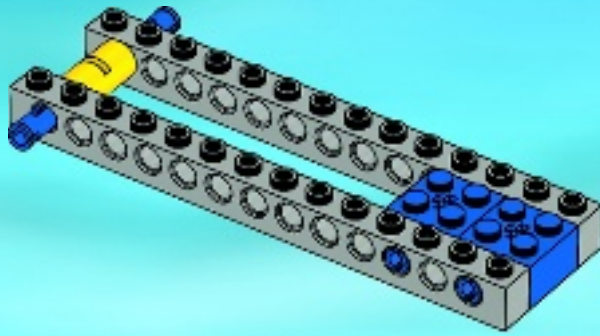

5

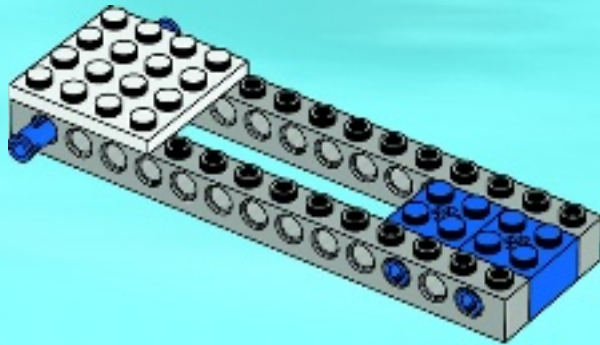

6

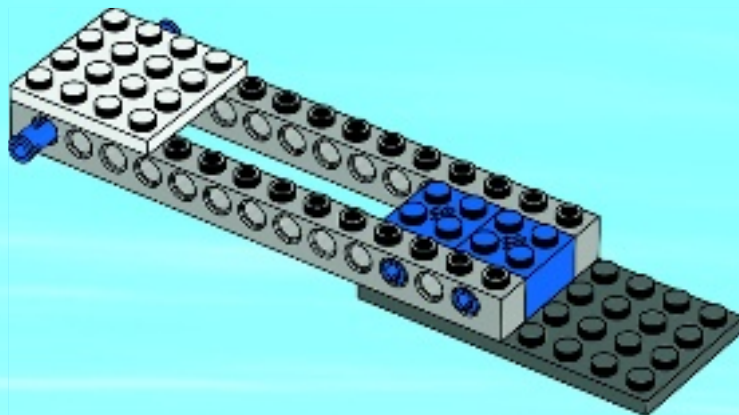



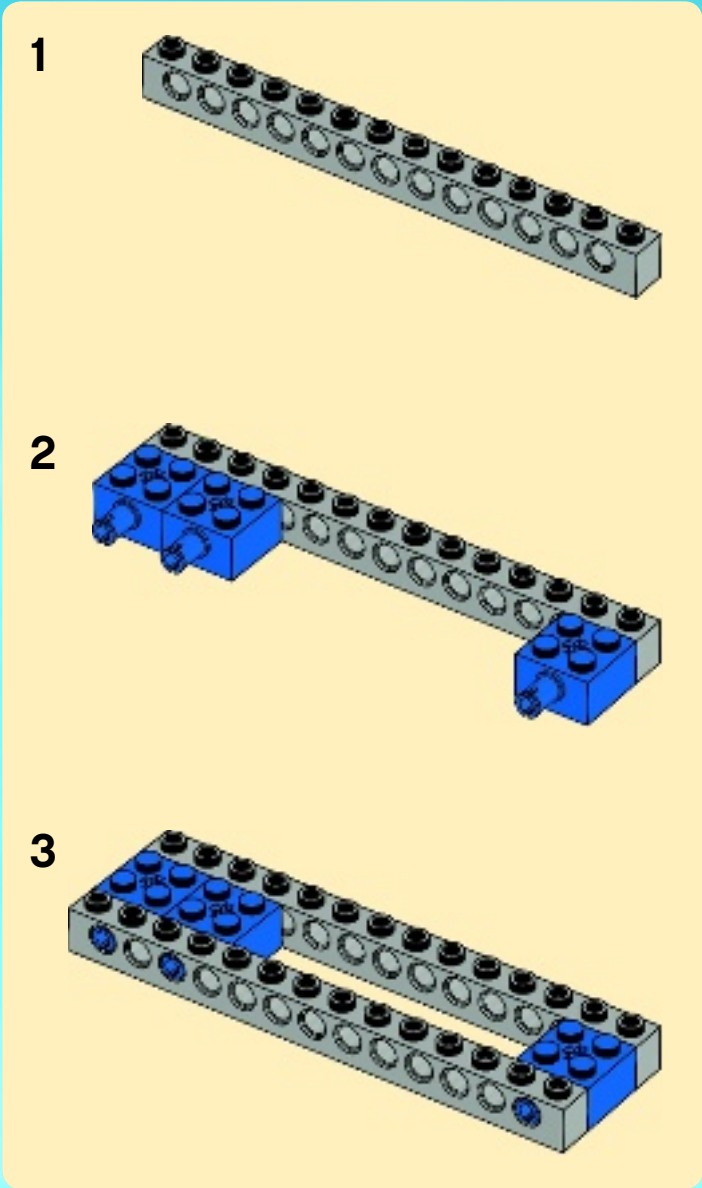

7

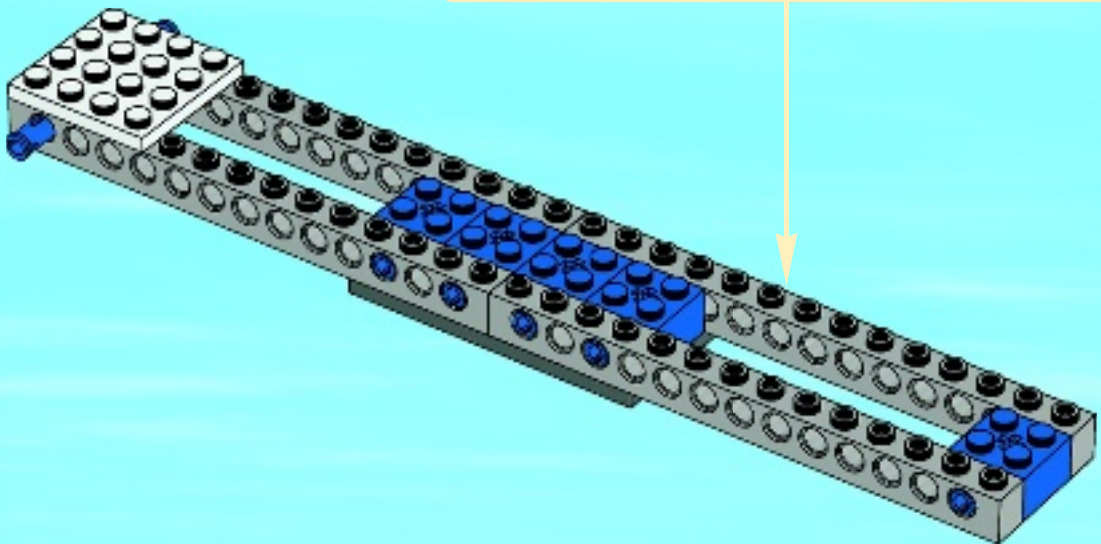

8

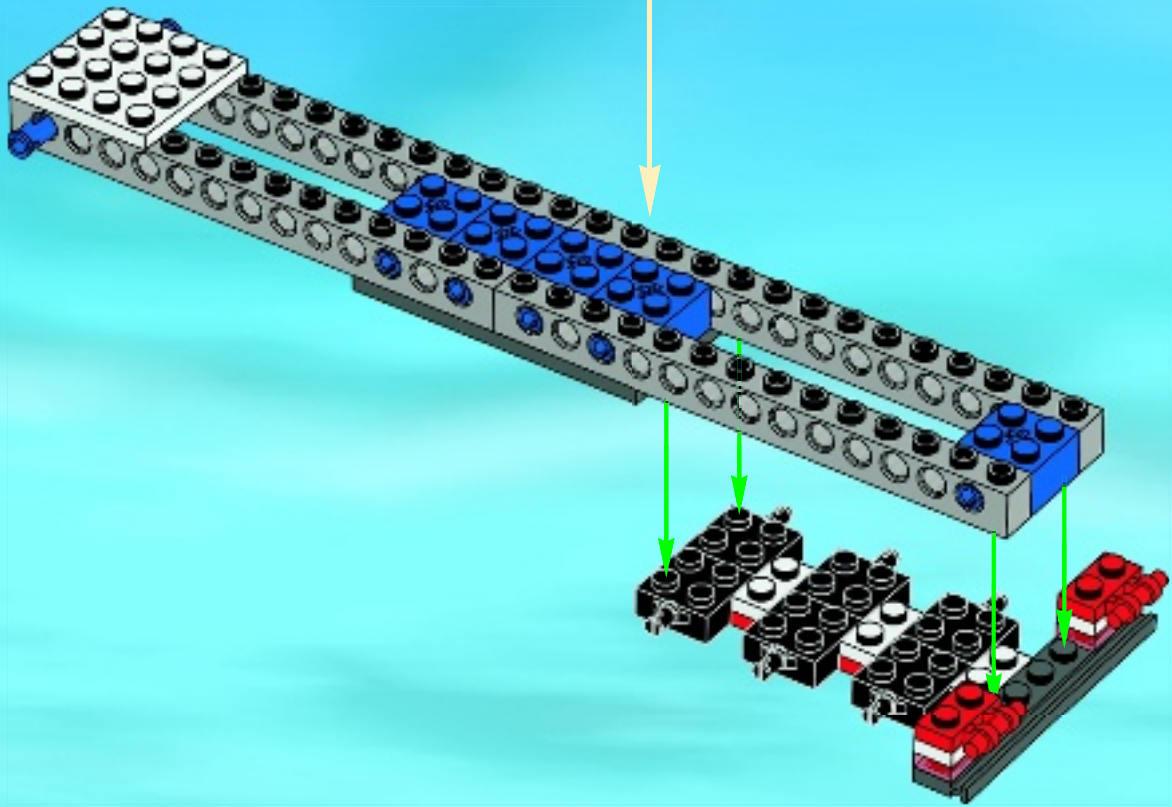

9

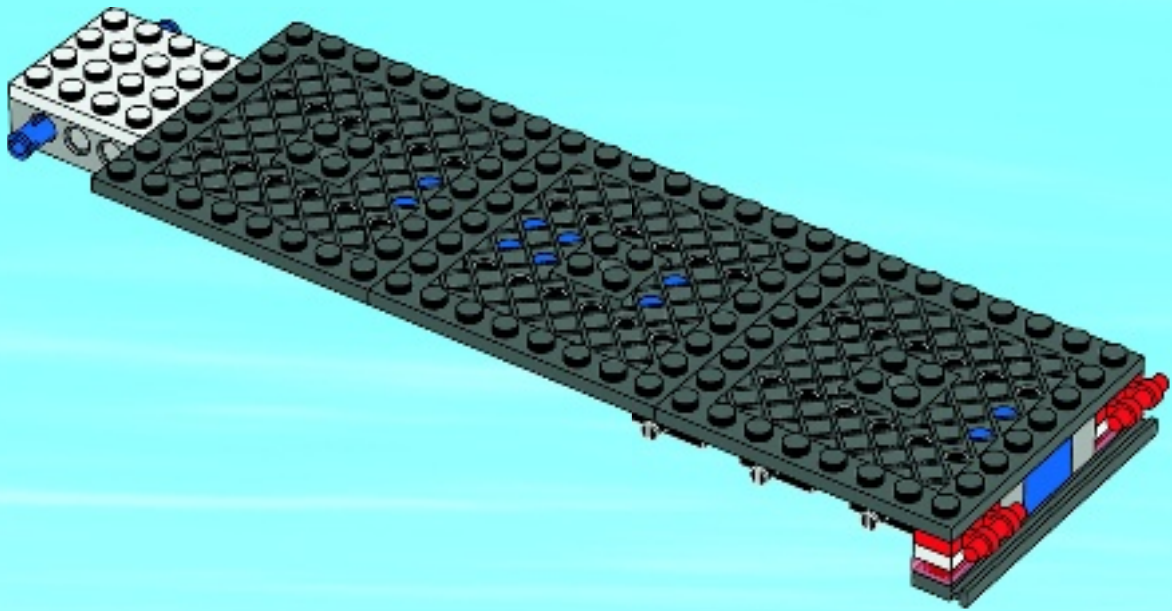



10

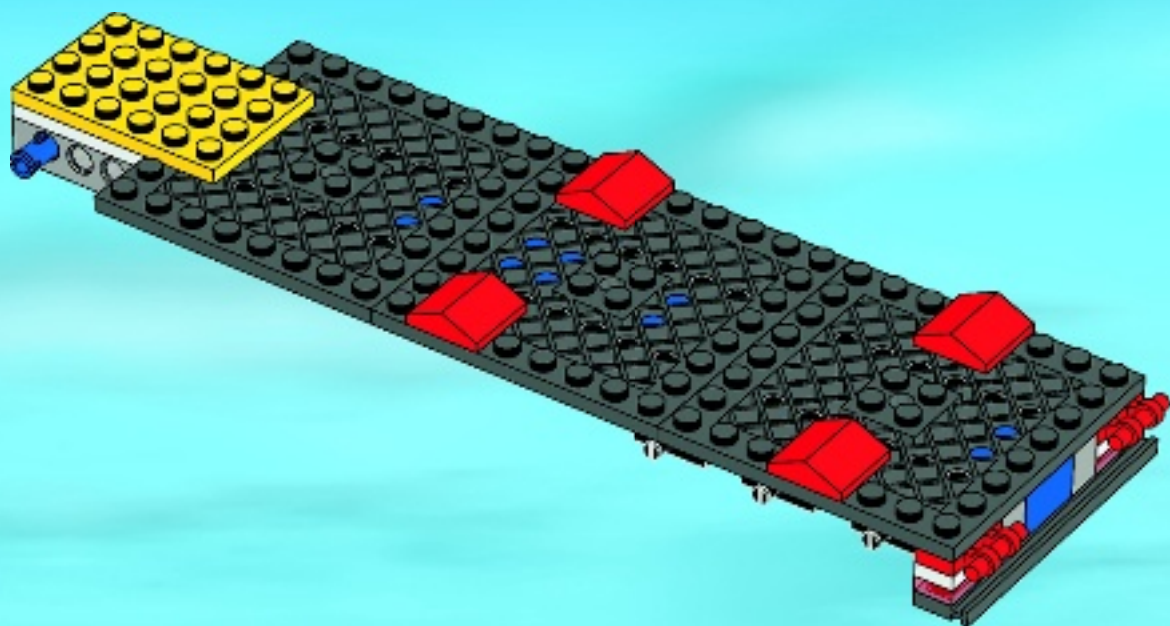

11

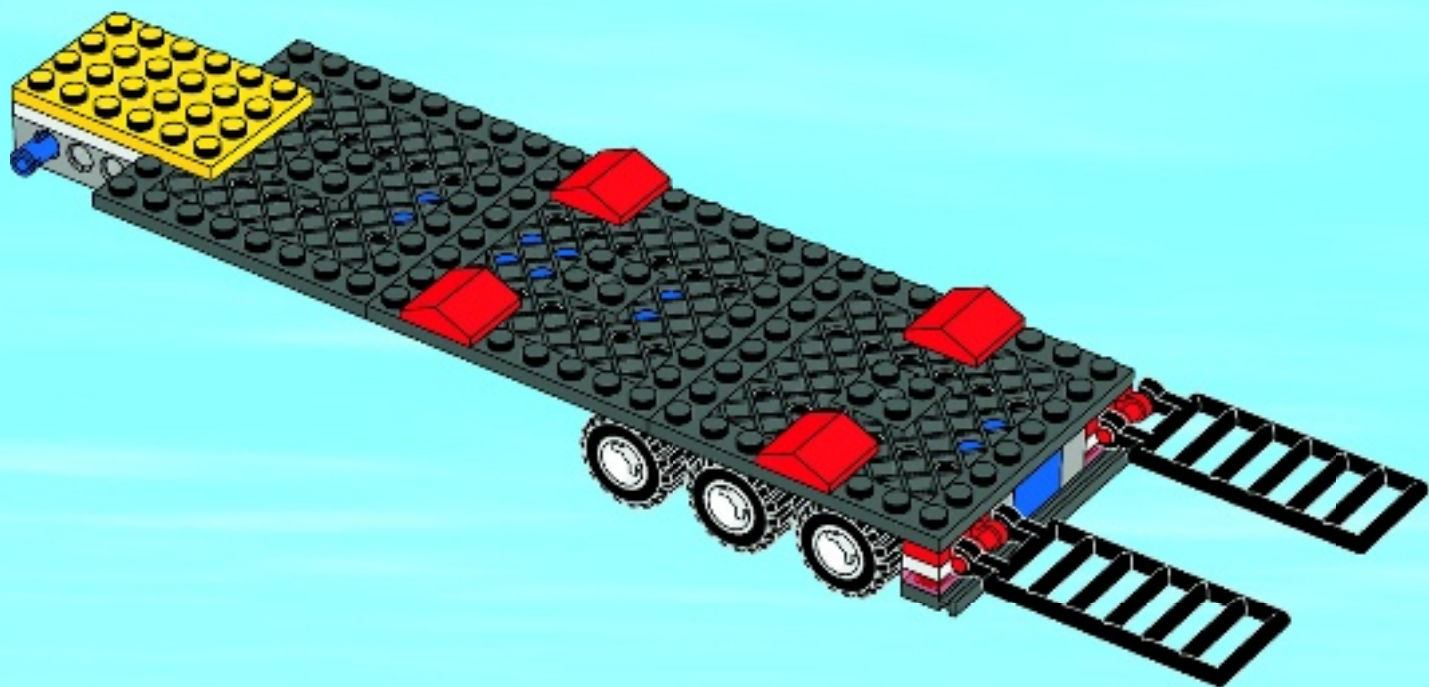

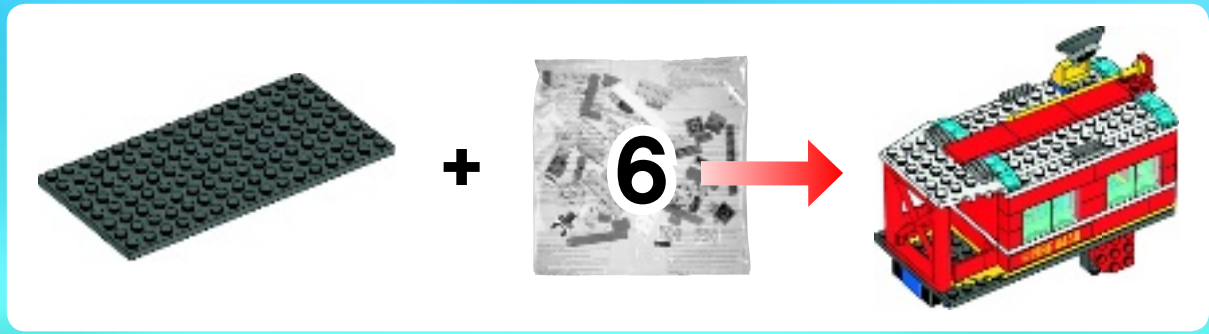

1



2

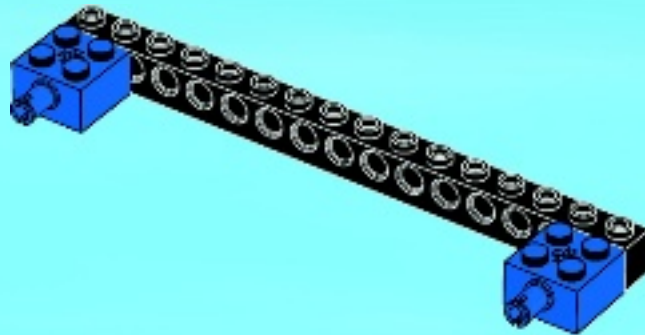

3

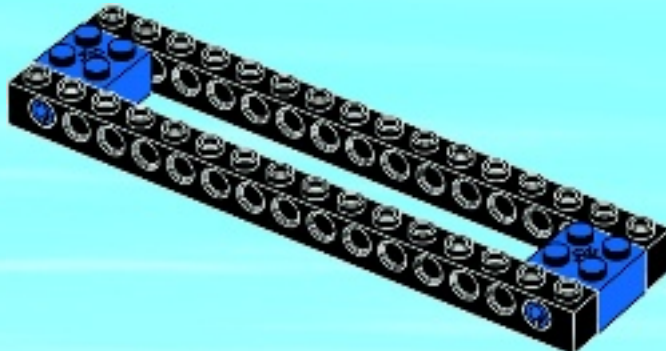



4

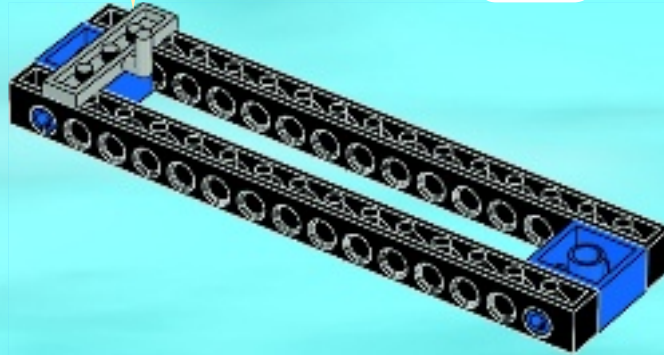
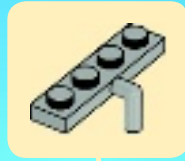

12

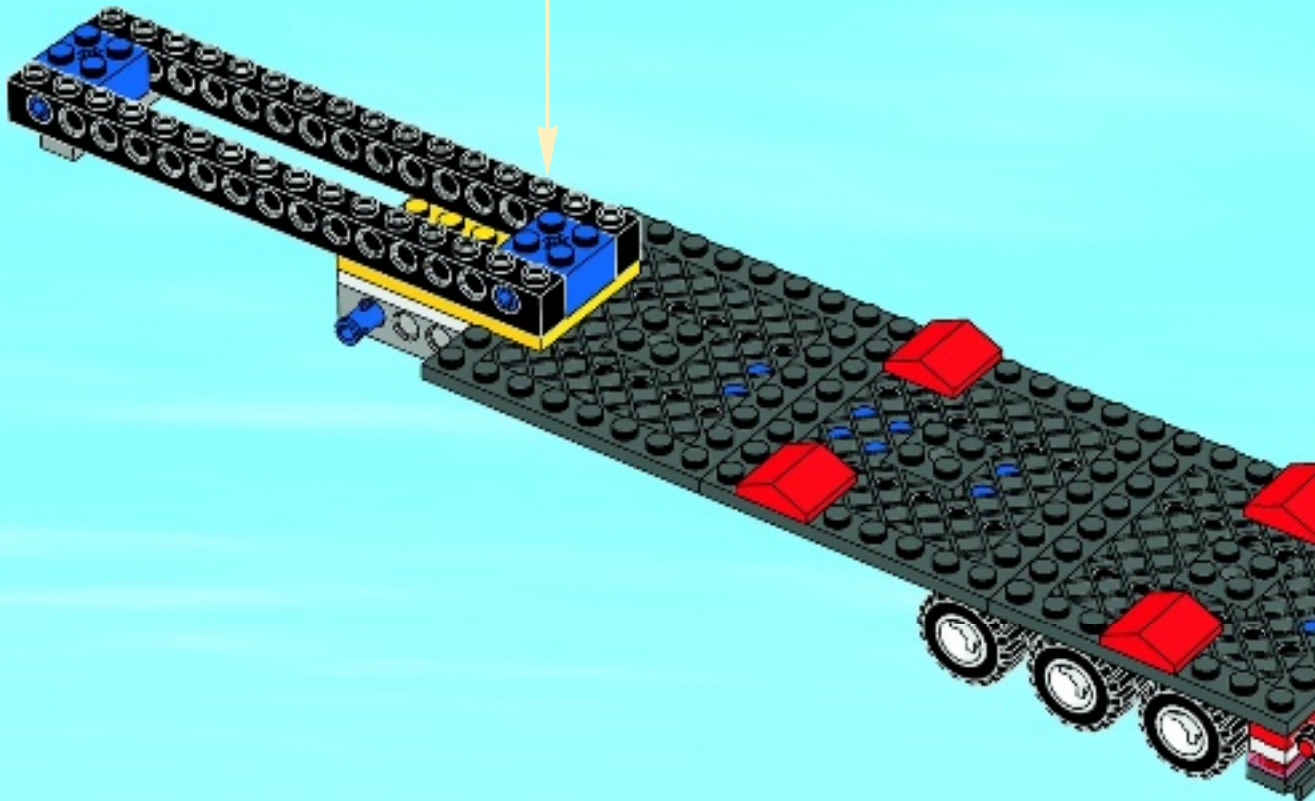

13

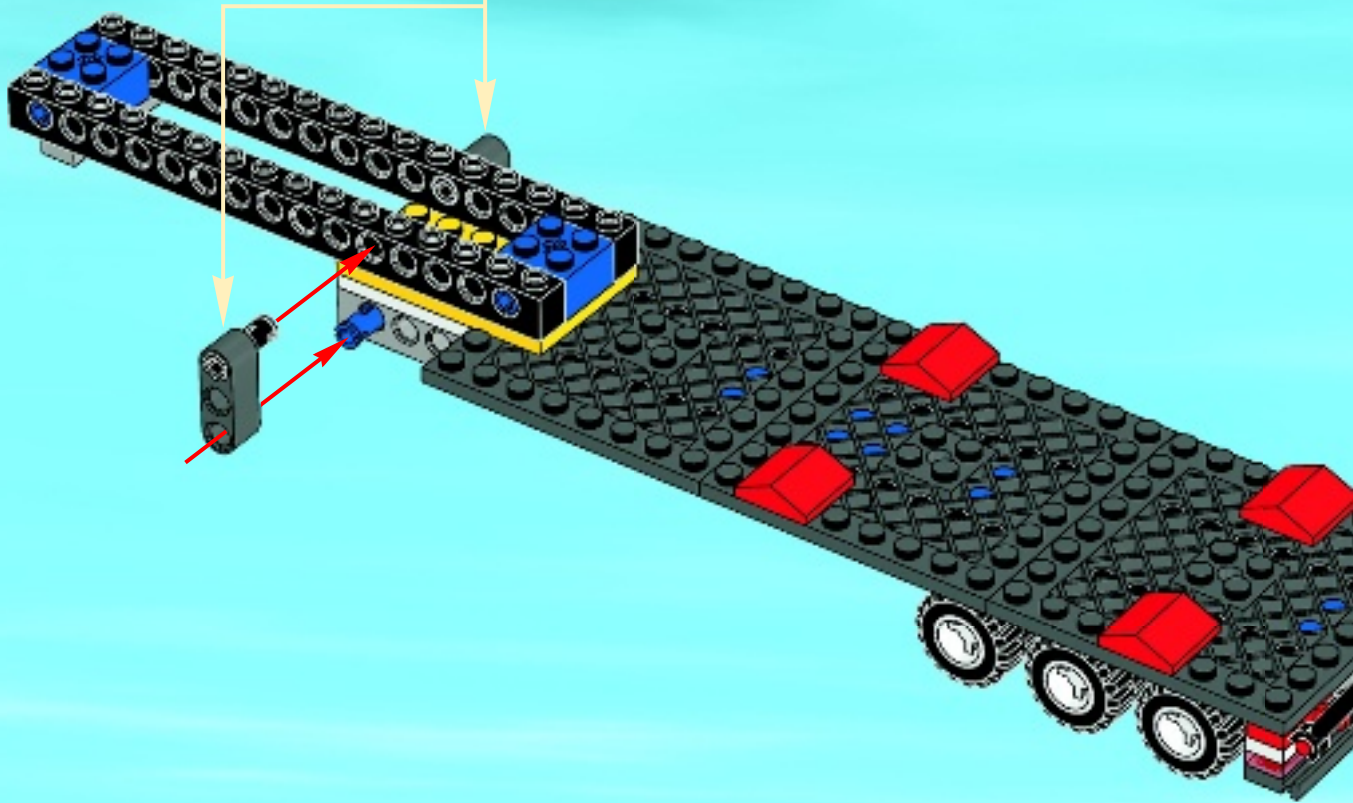
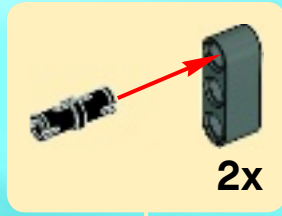

14

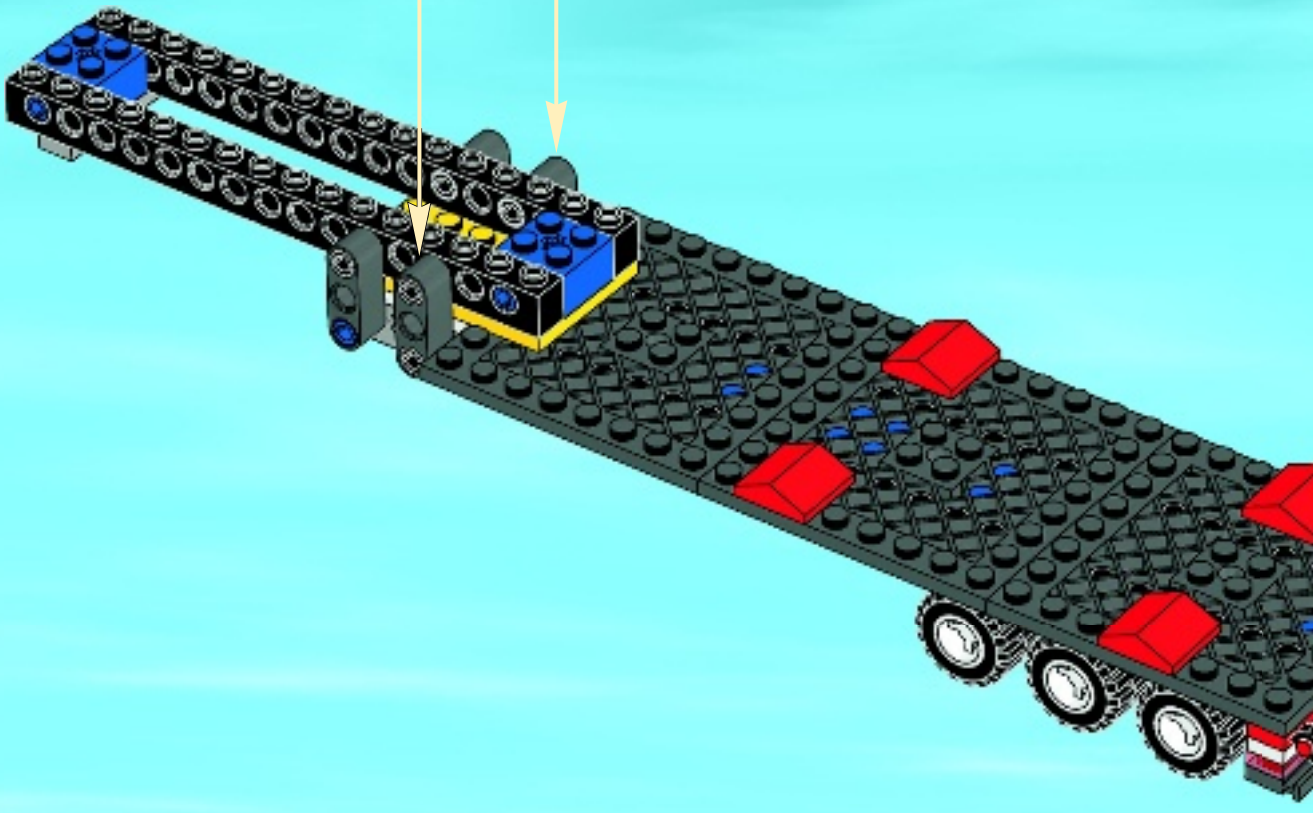
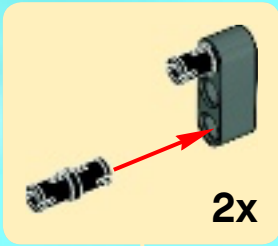



15

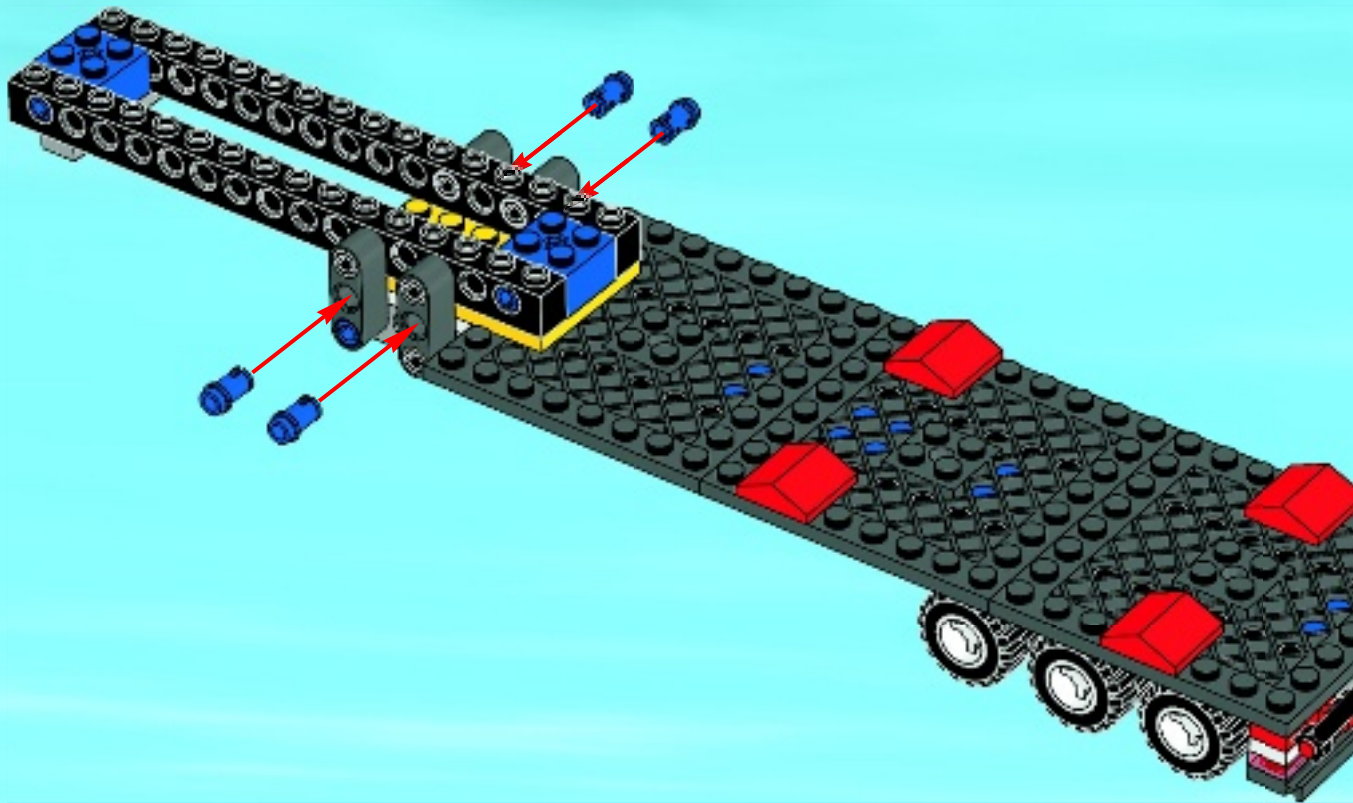

16

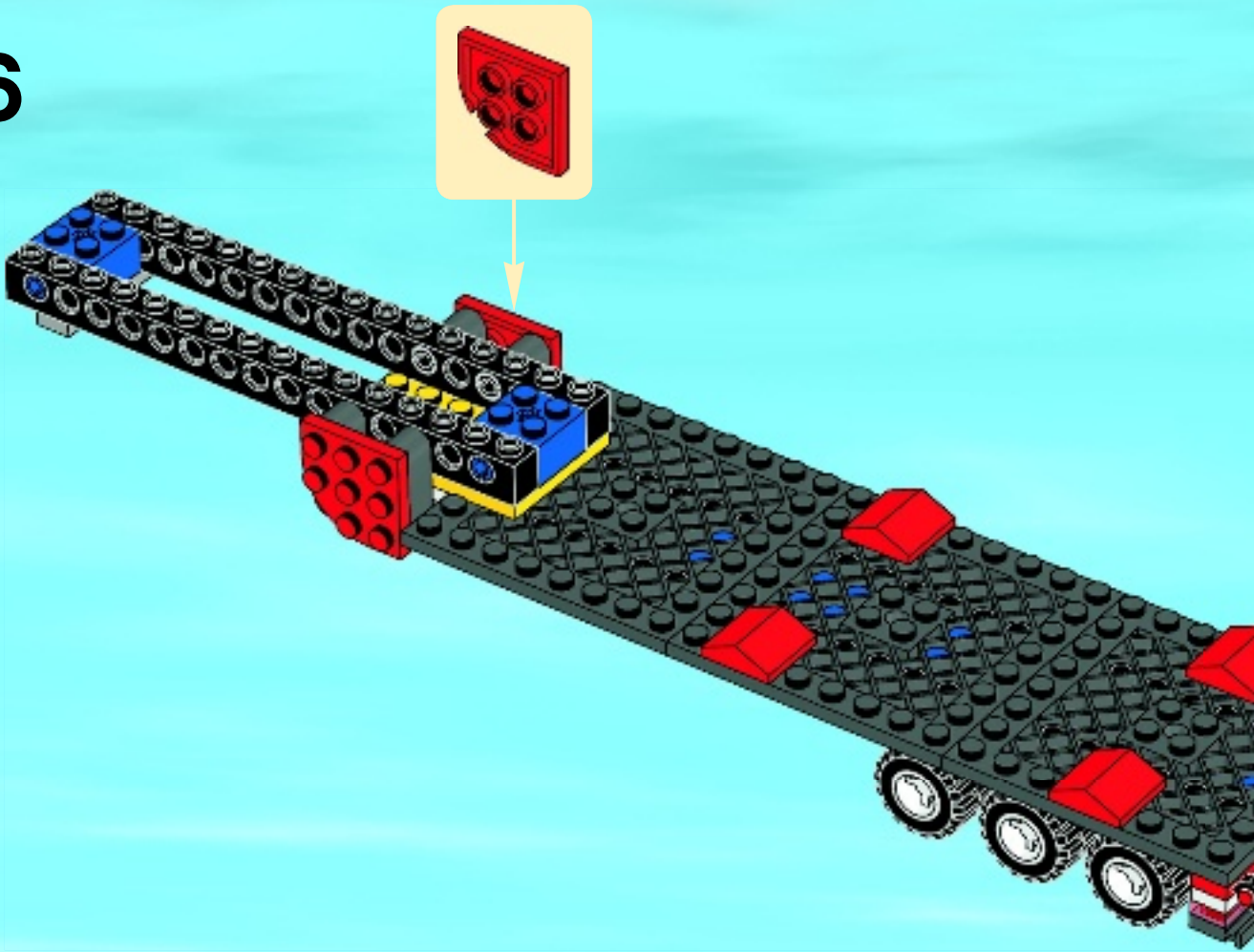

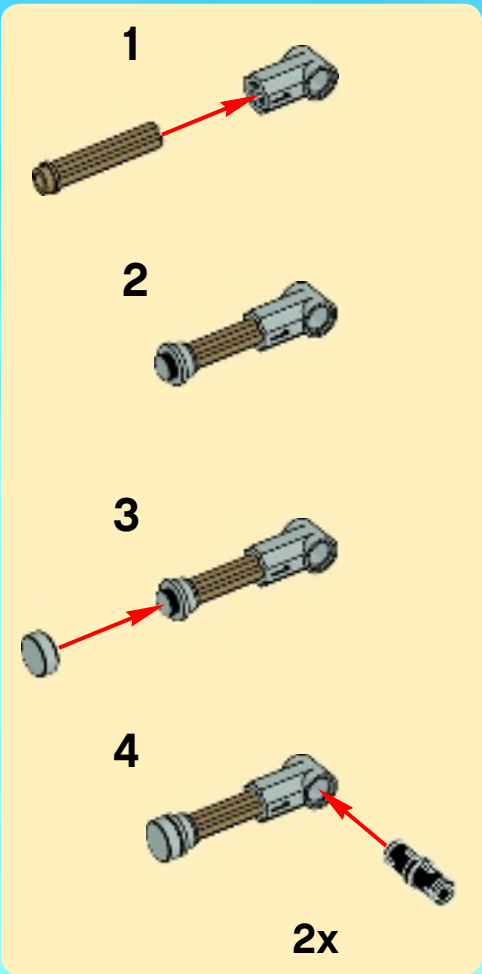

17

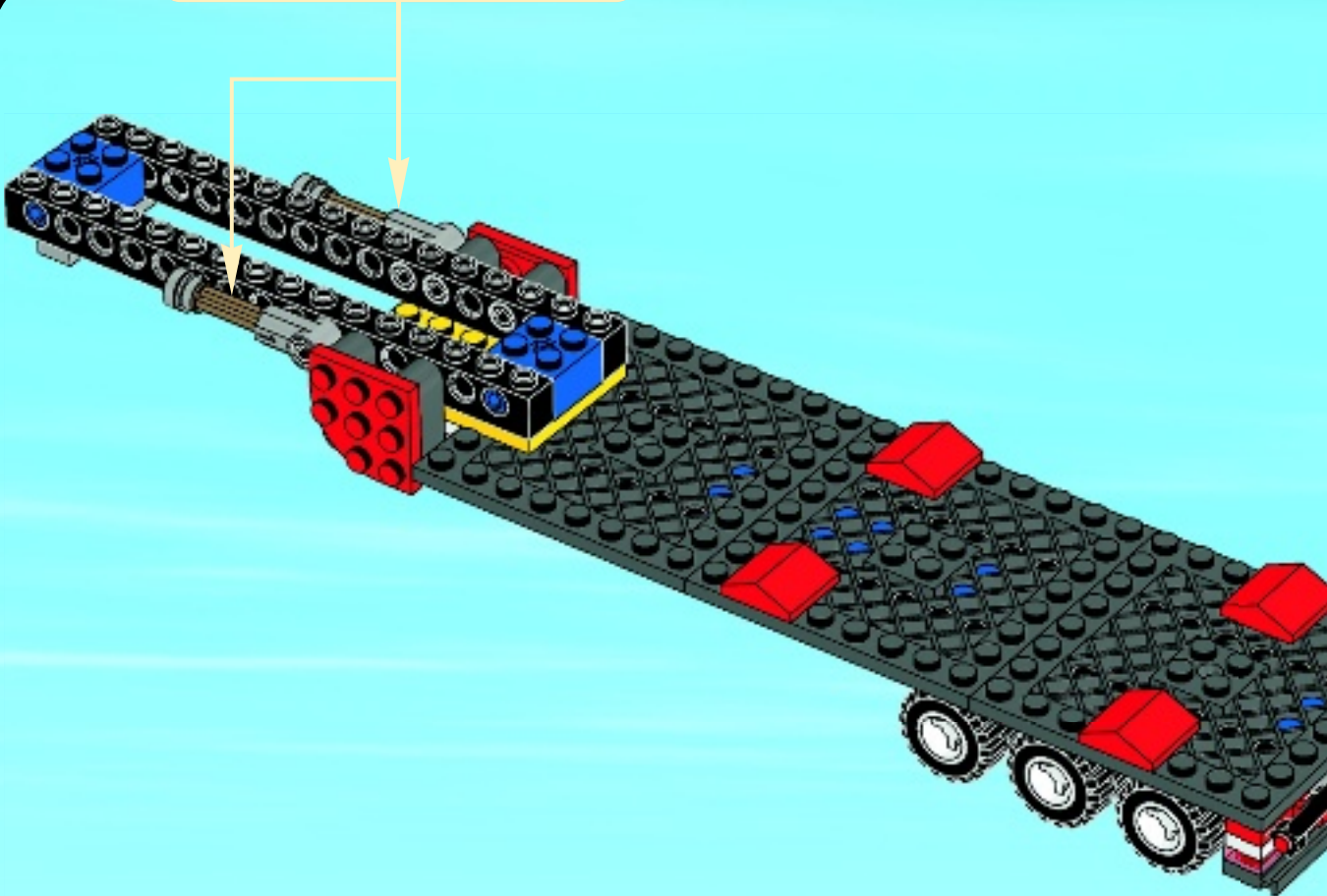



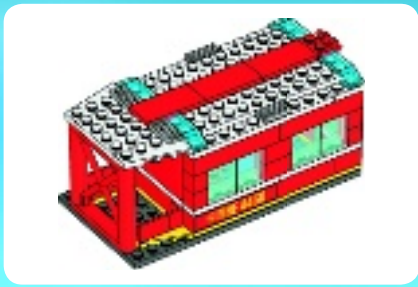

1

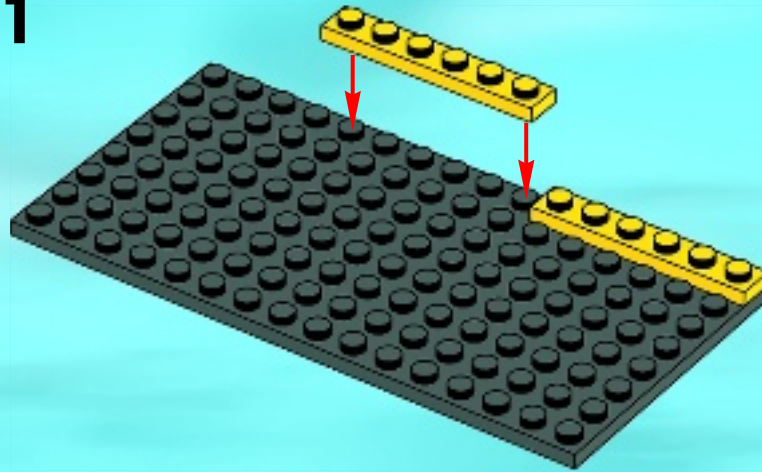

2

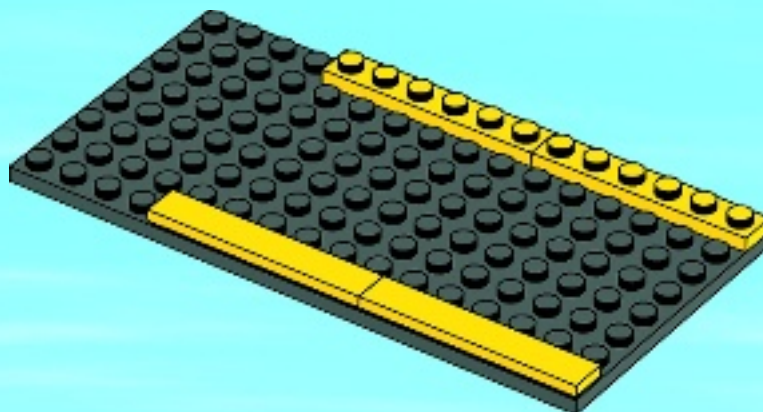

3

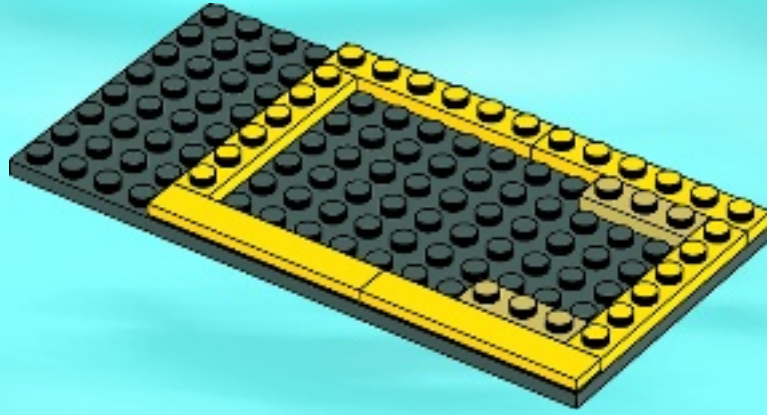

4

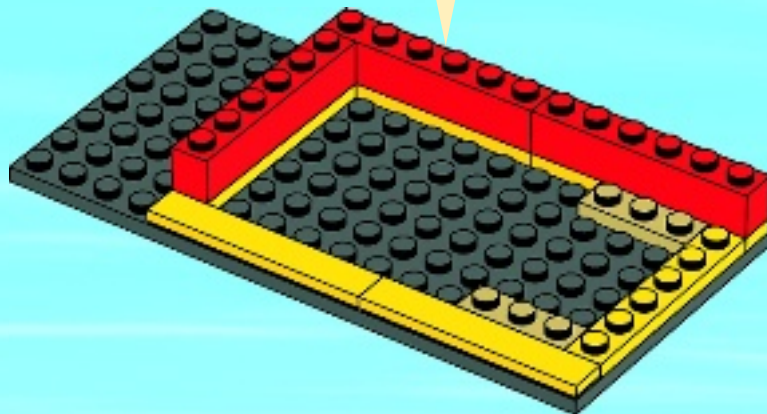

5

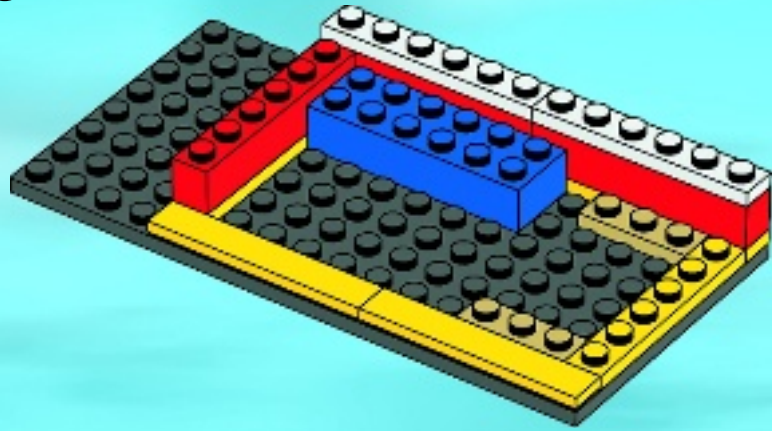

6

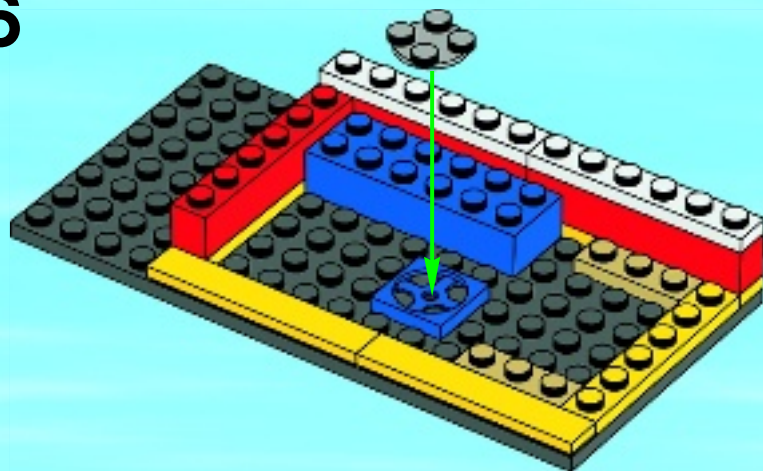



7

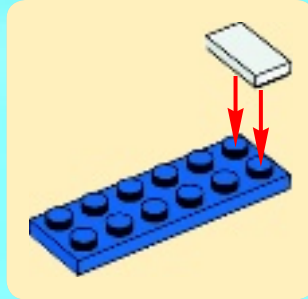
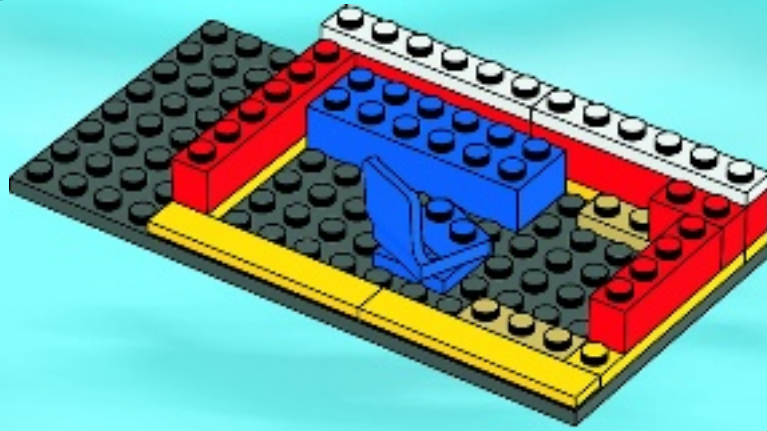

8

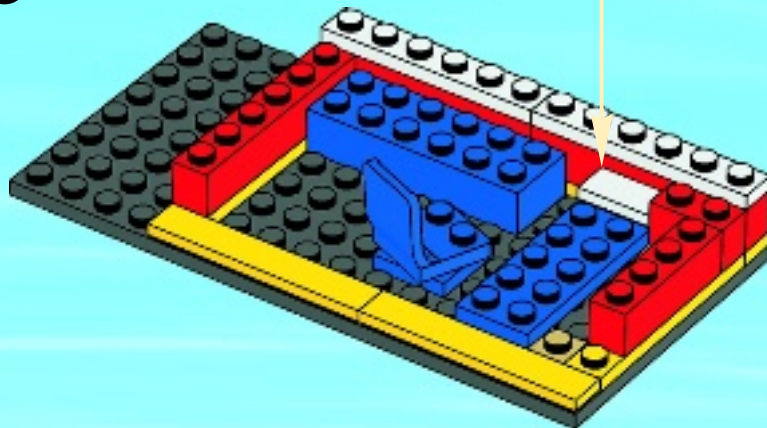

9

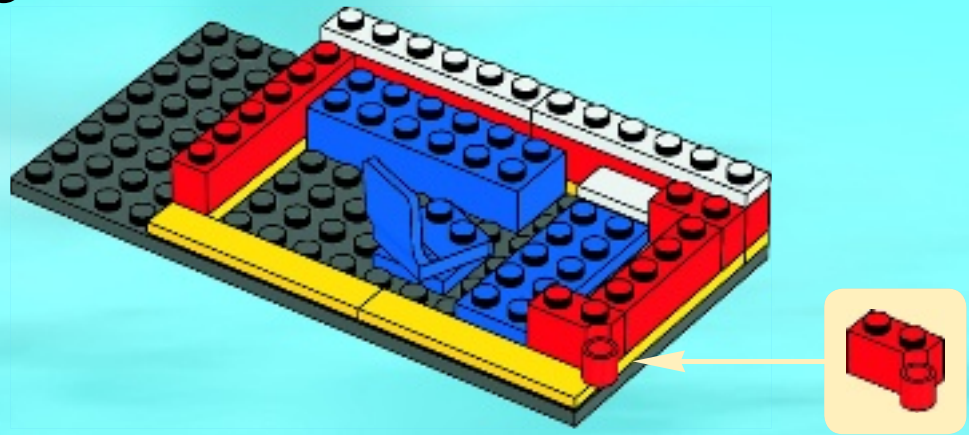

10

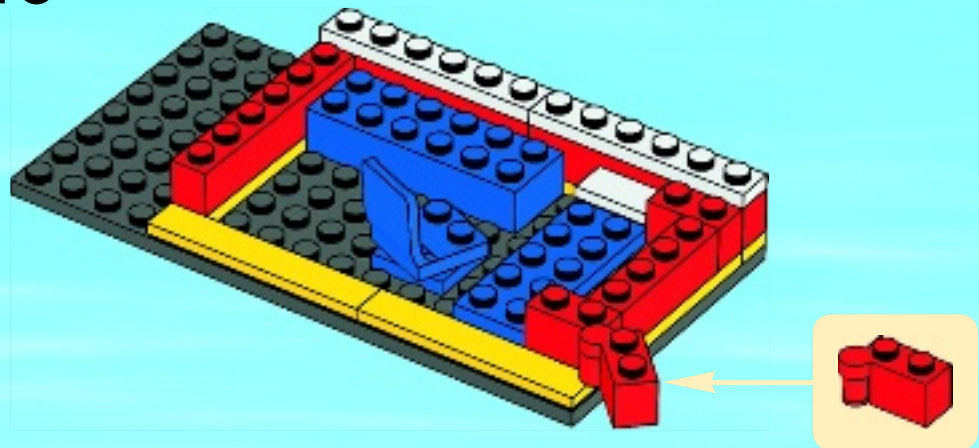

# 11

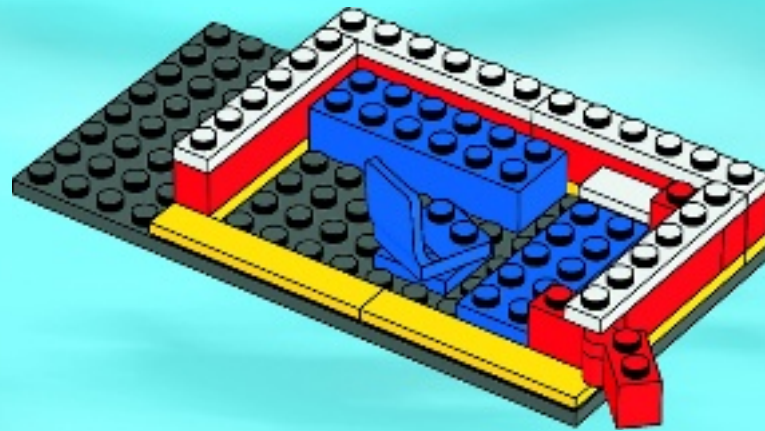

1



2



3



# 12

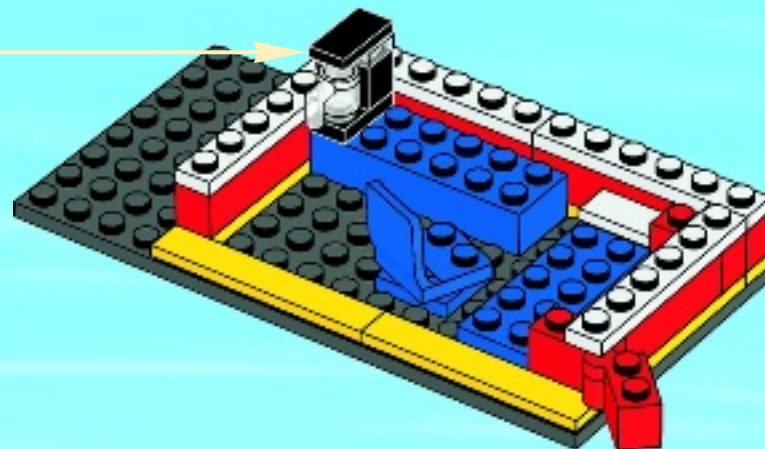



13

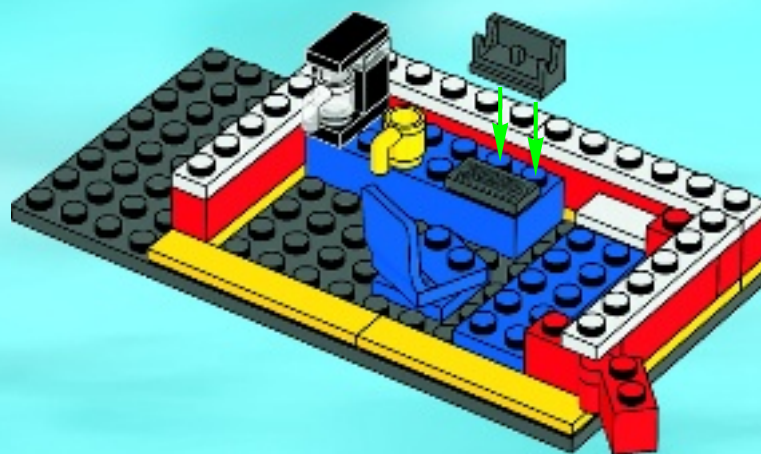

14

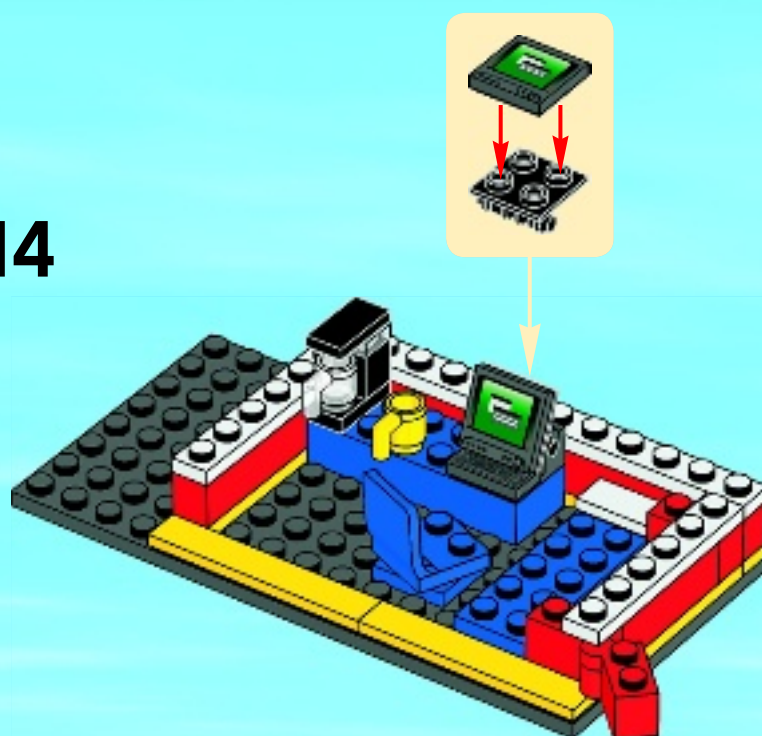

15

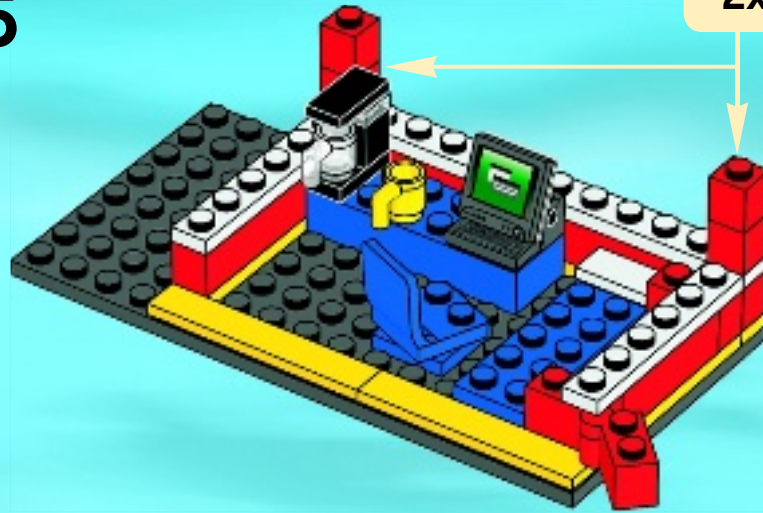

16

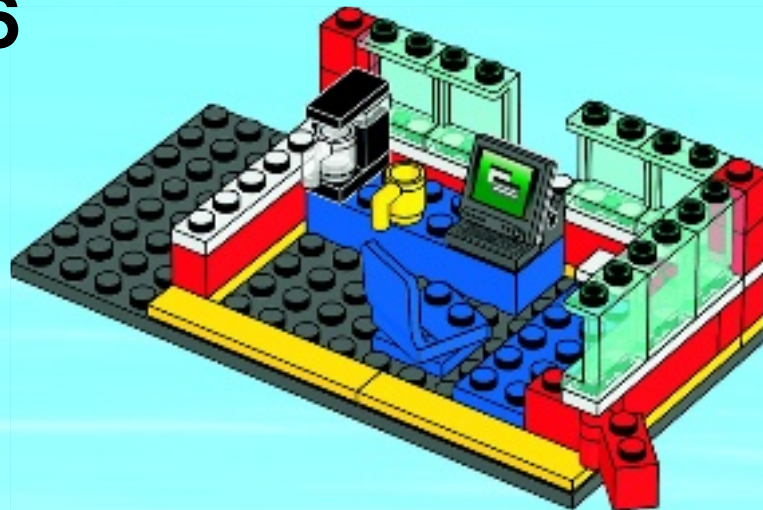

17

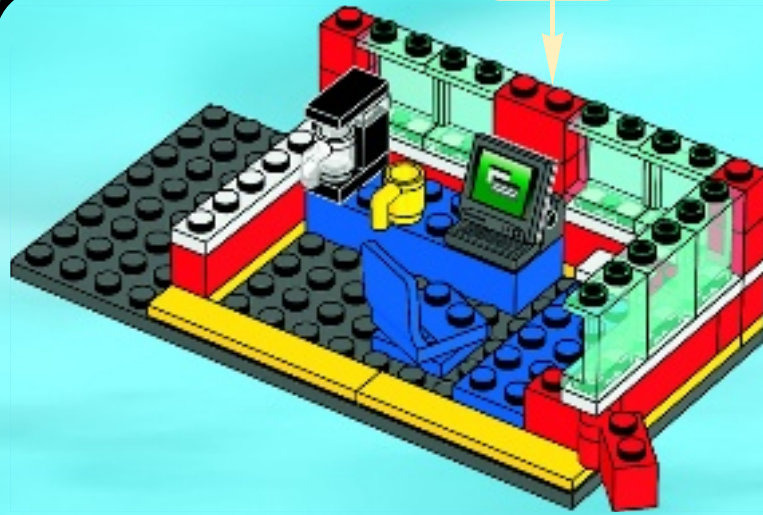

18

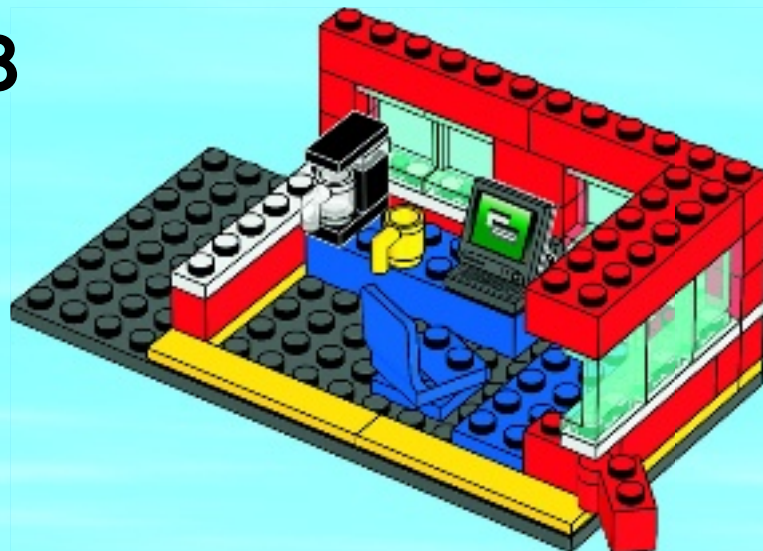



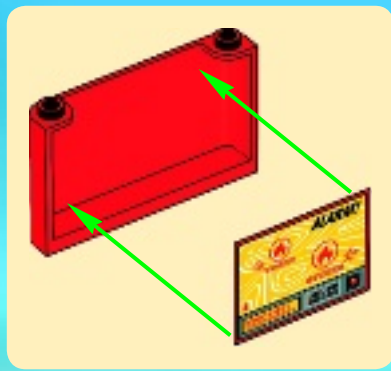

19



20

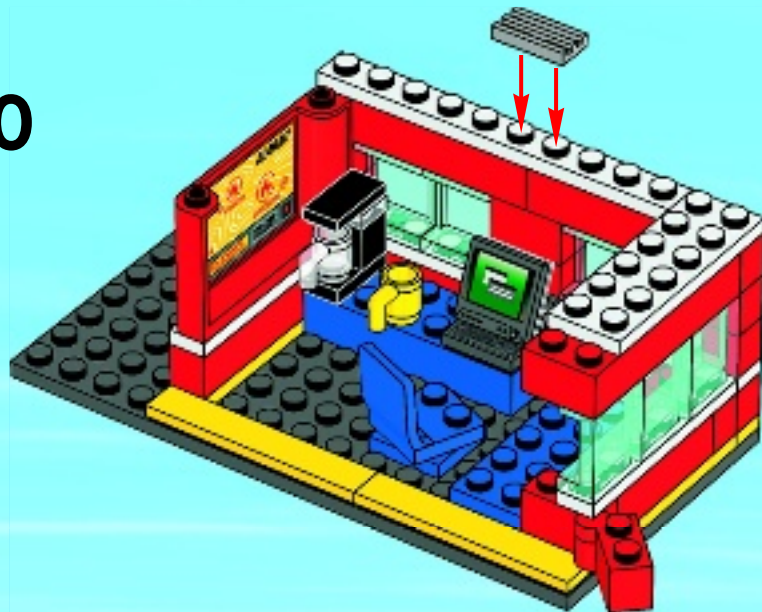

21

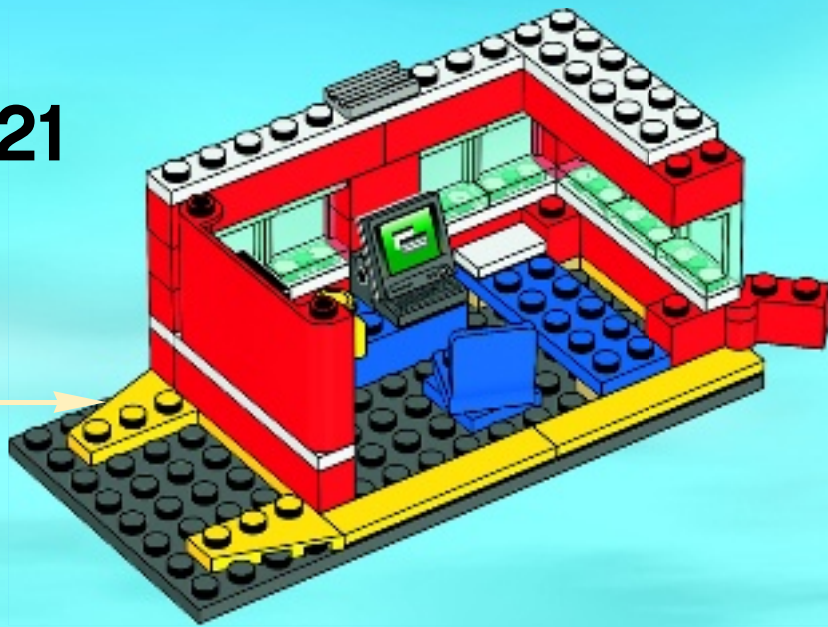
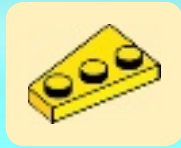

22

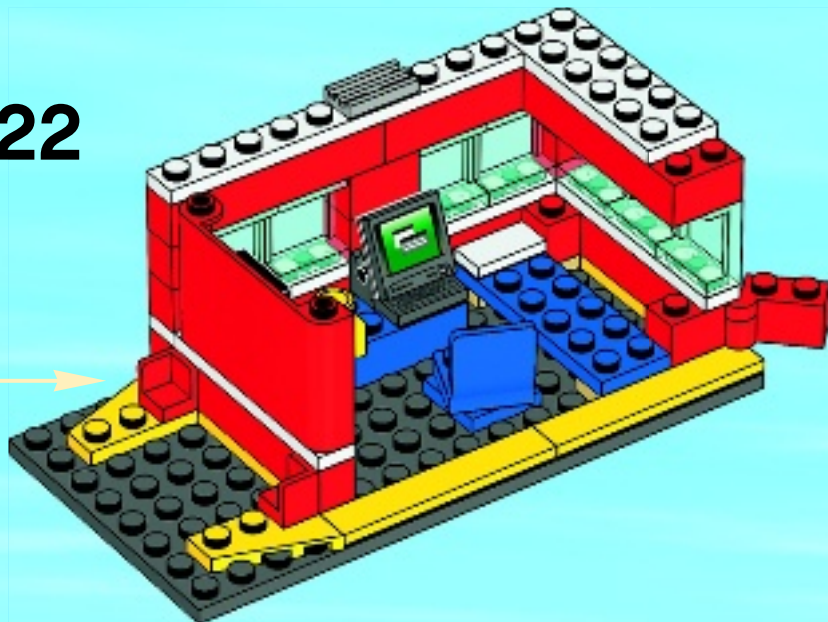
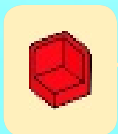

23

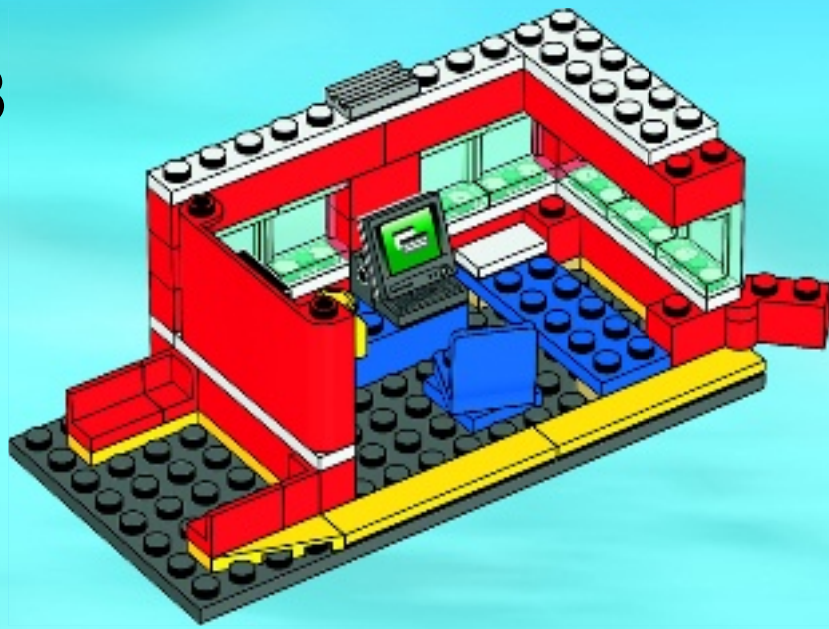

24

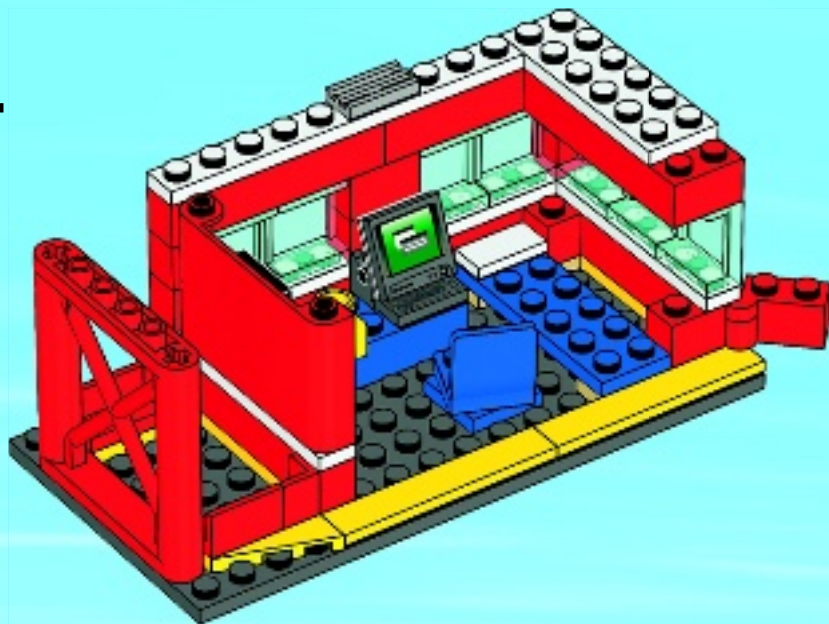



1



2



25

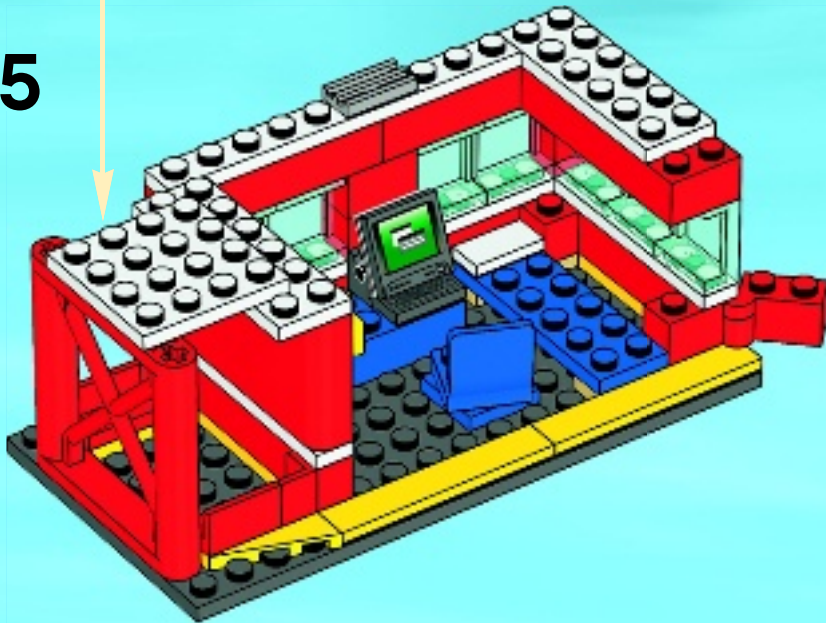

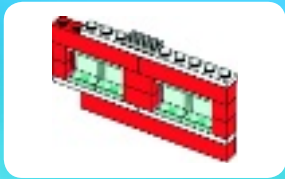

1

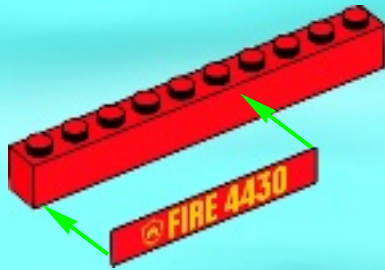

2

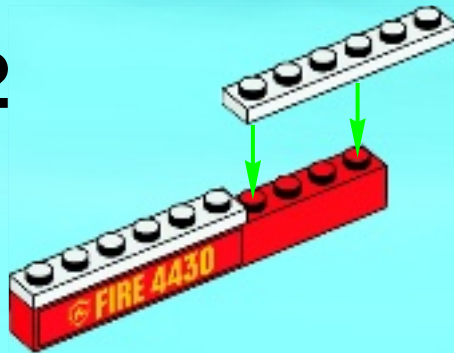

3

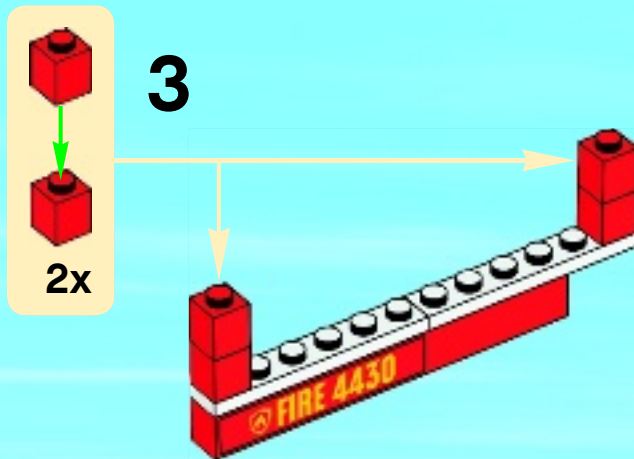

4

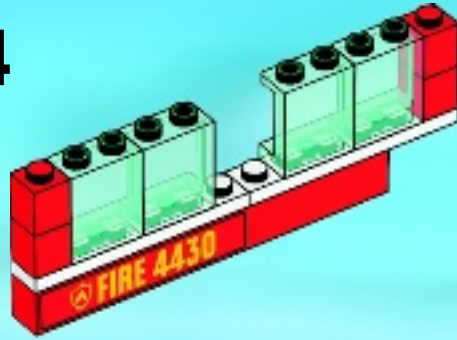

5

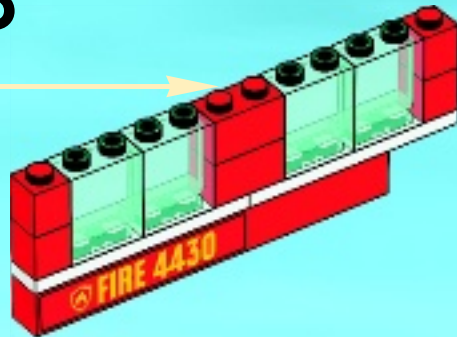
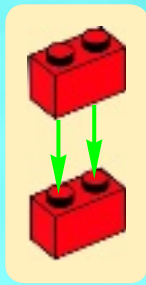

6





7

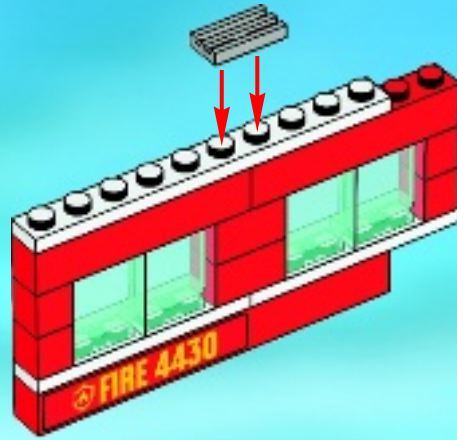

8

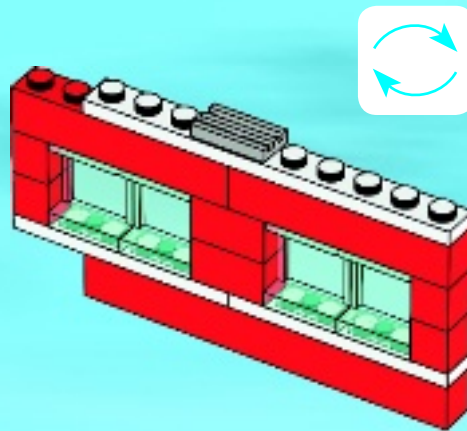

26

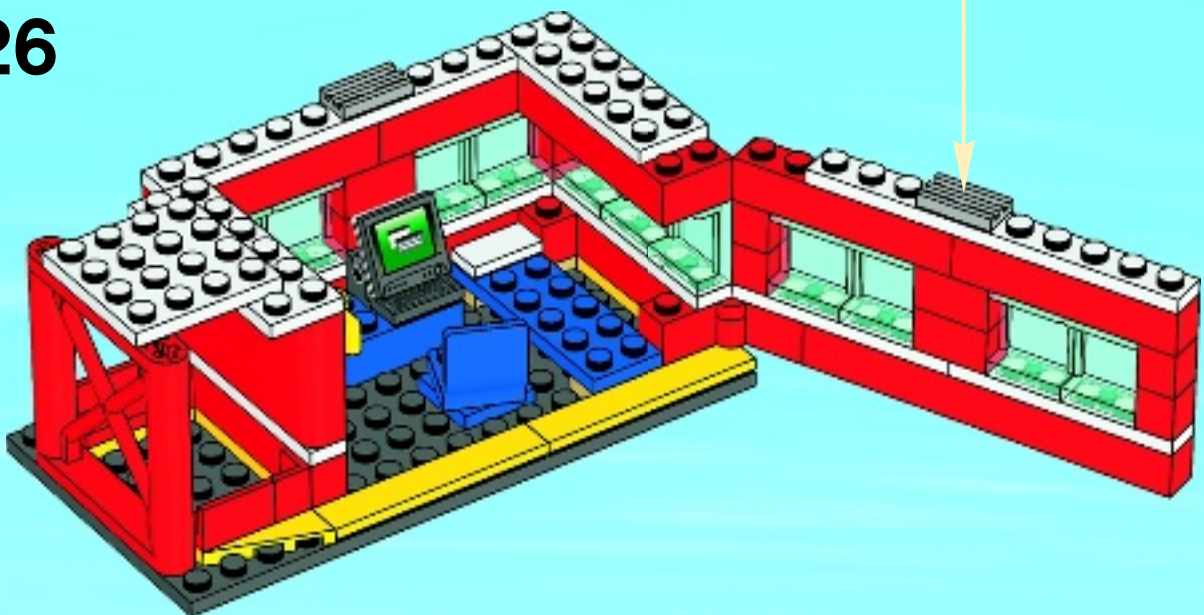

27

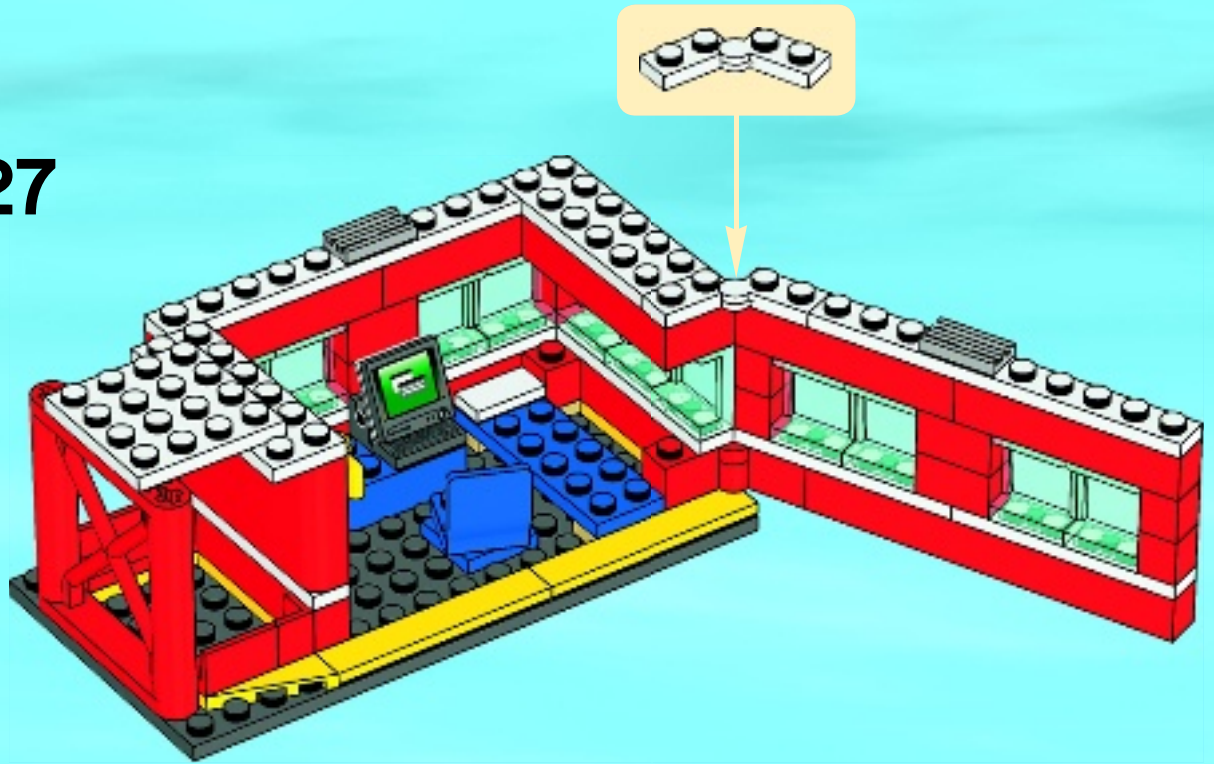

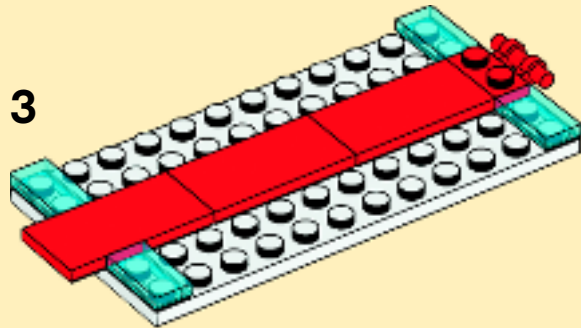
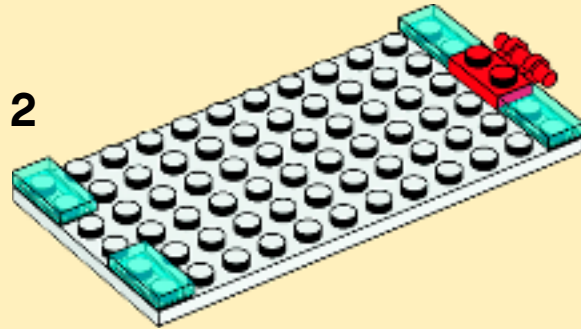
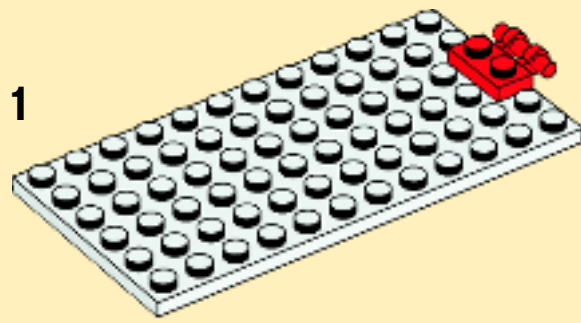

28

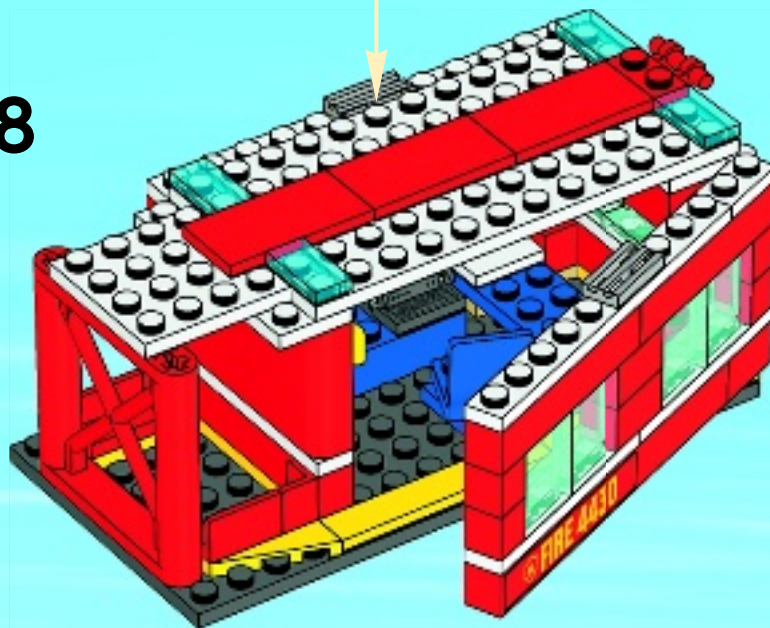



29

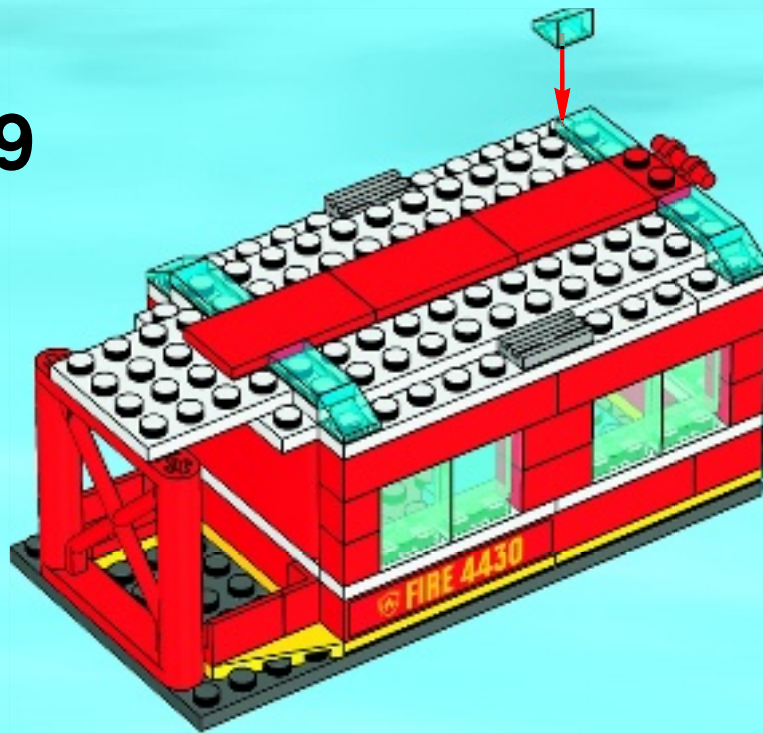

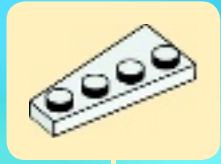

30

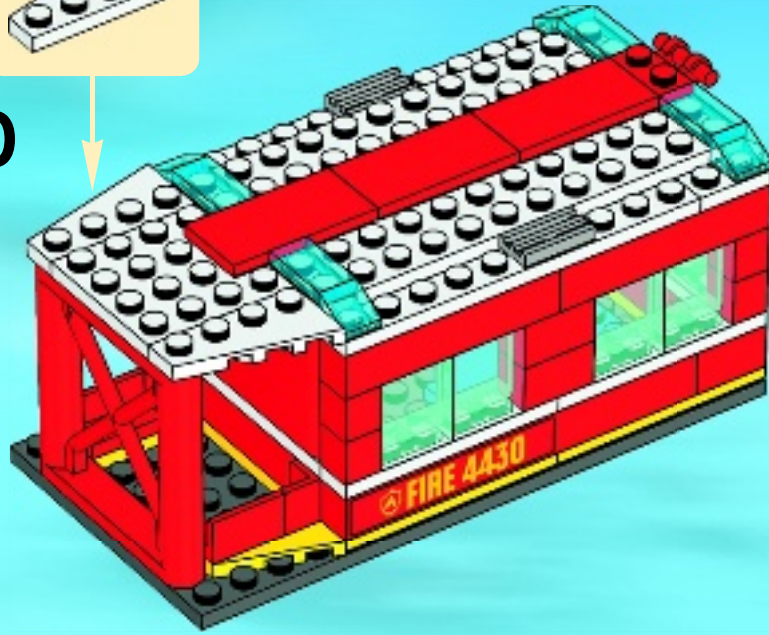

31

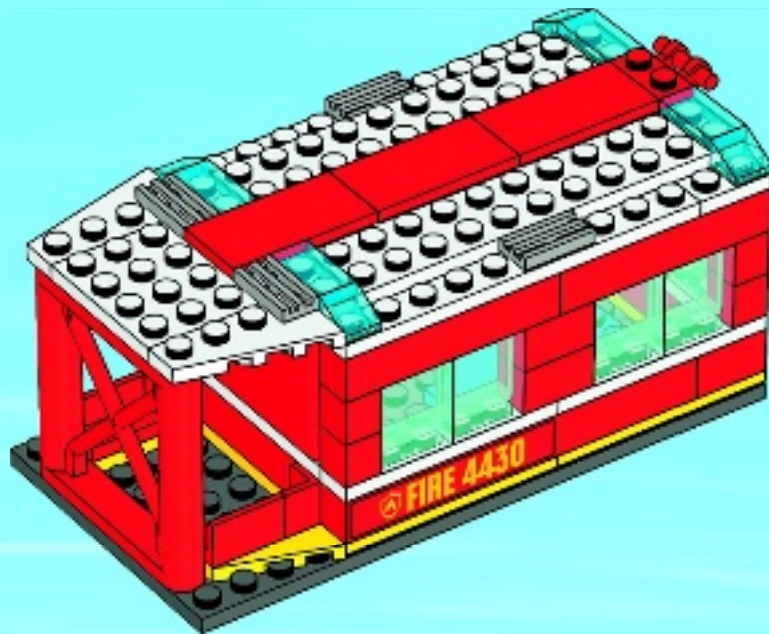

32

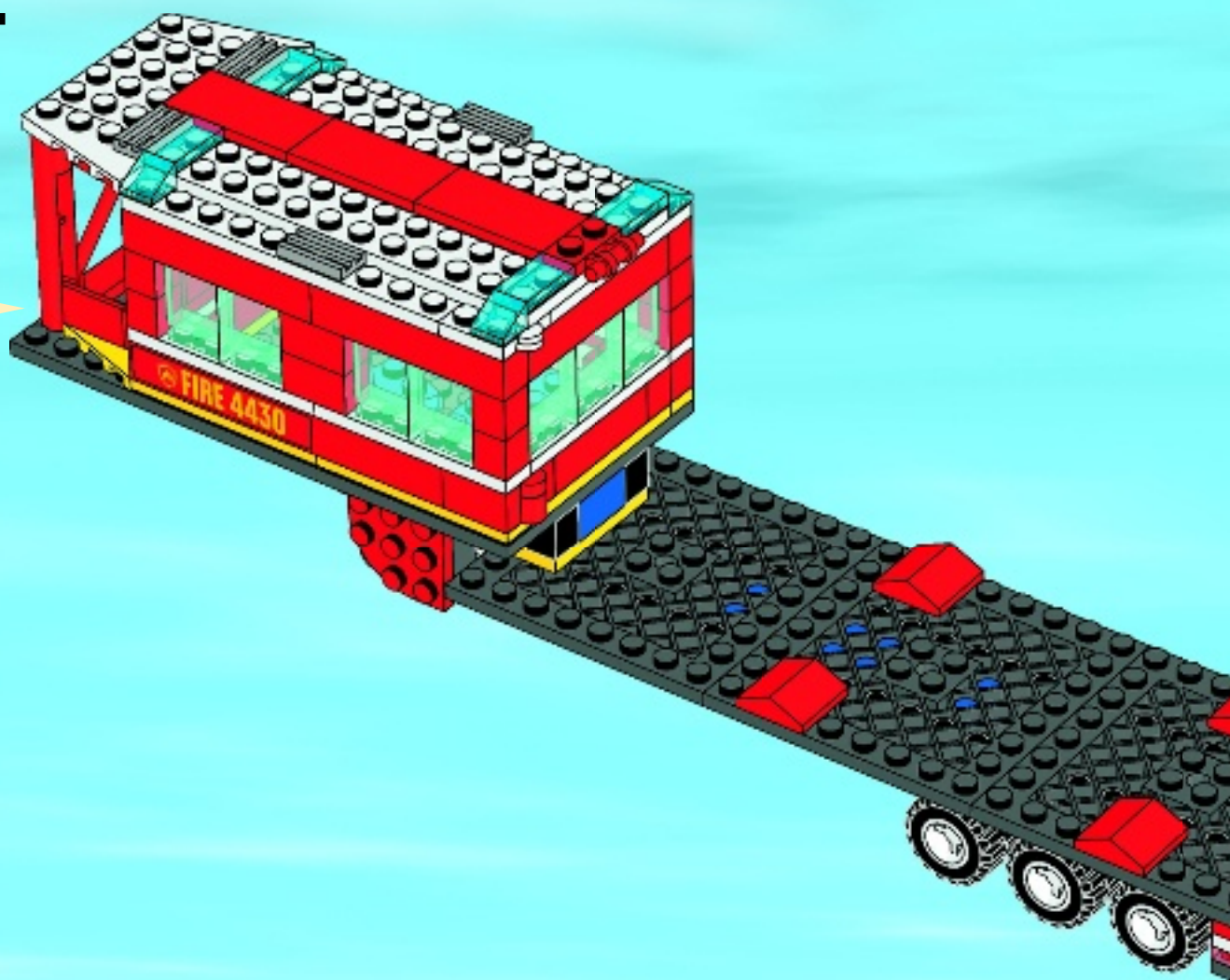



33

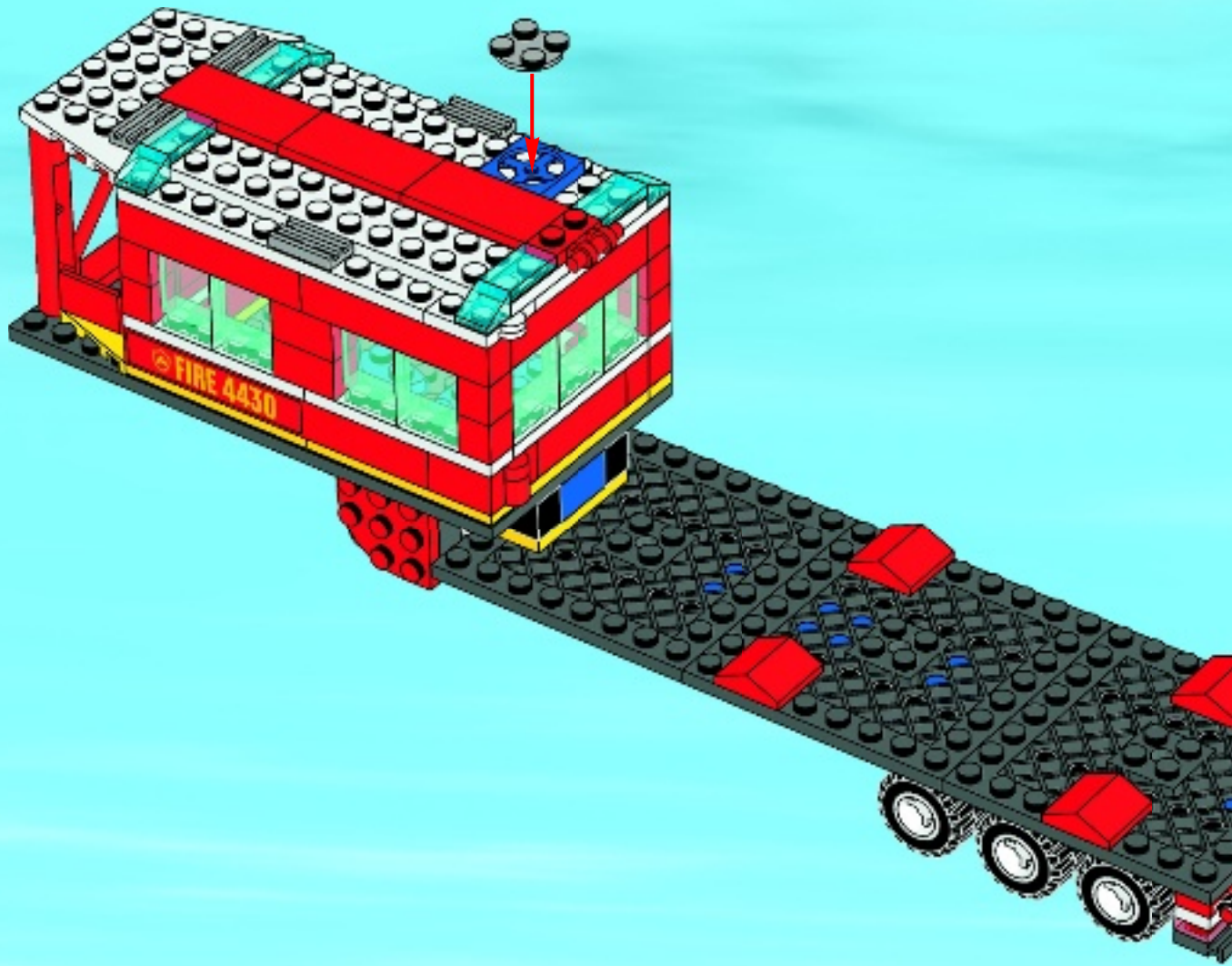

34

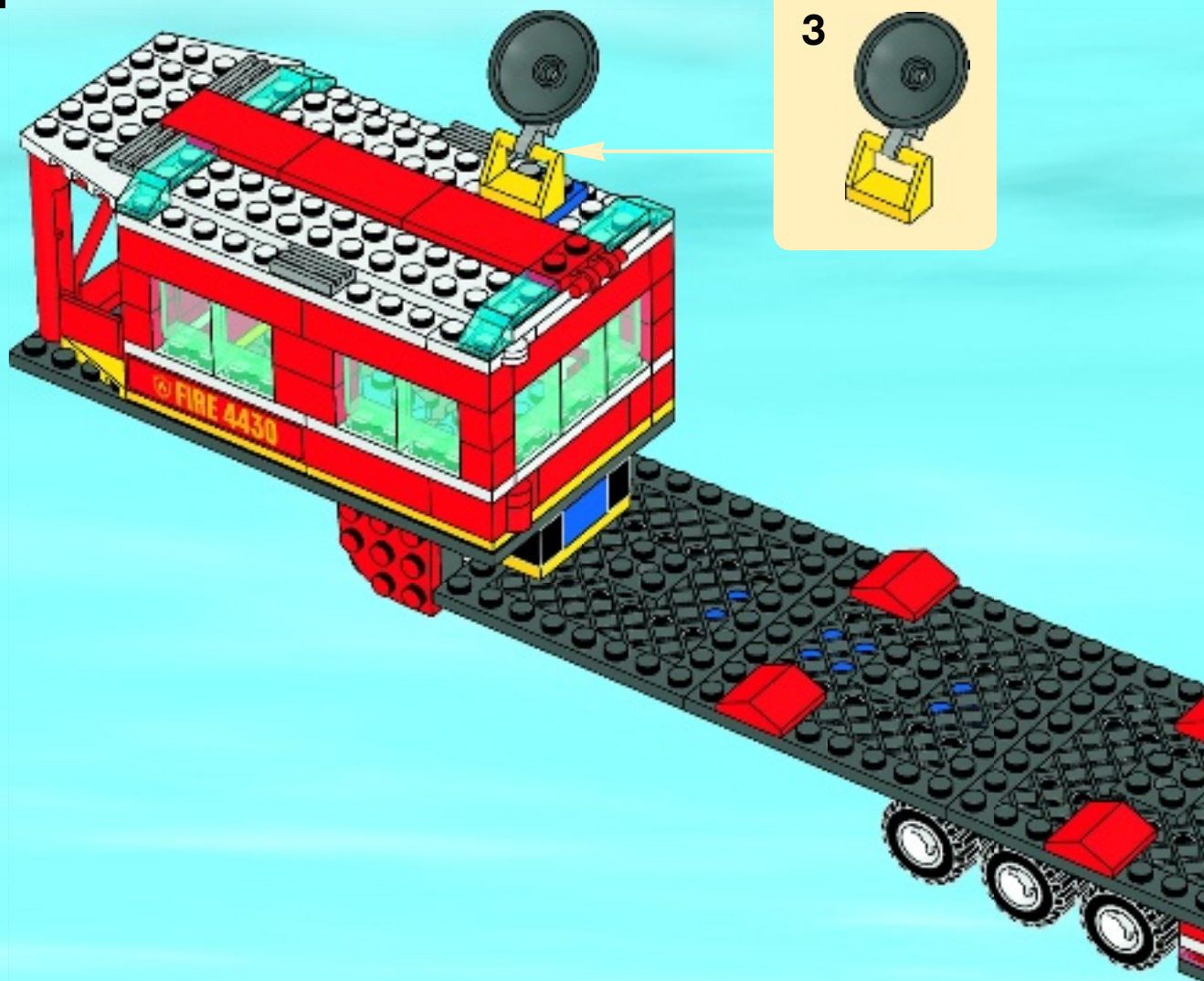

1



2



3



35

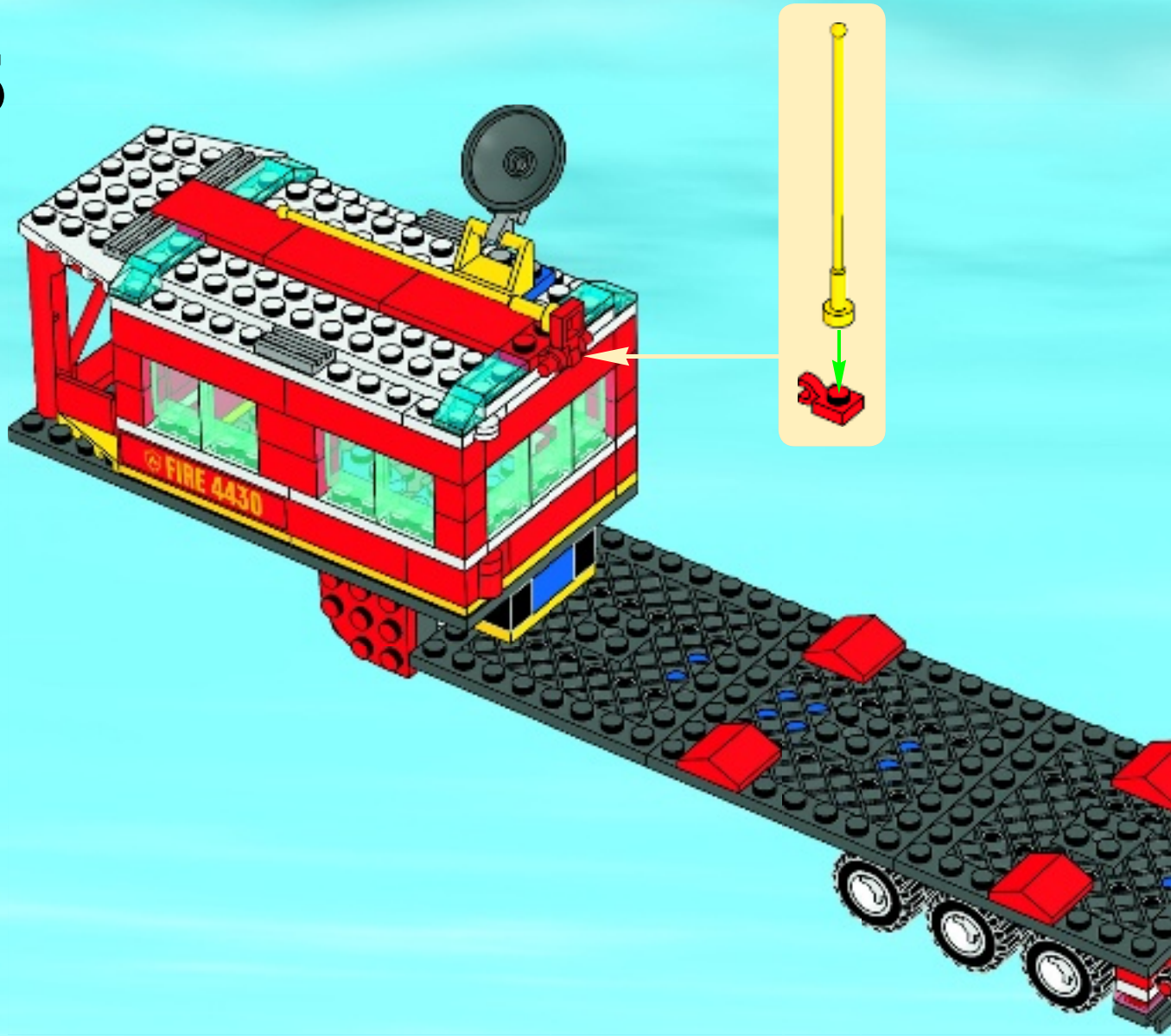







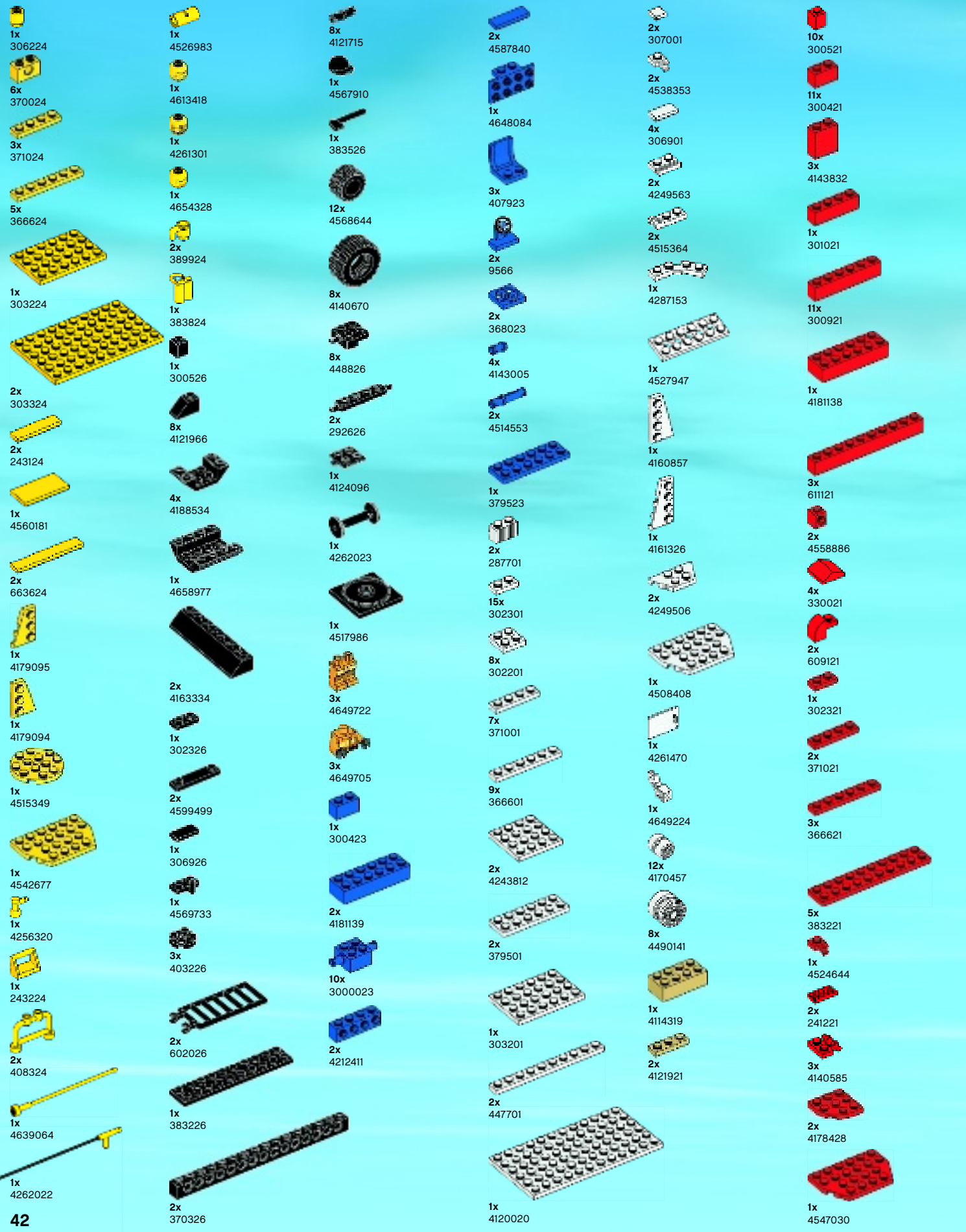

1x 306224  
 6x 370024  
 3x 371024  
 5x 366624  
 1x 303224  
 1x 303224  
 2x 303324  
 2x 243124  
 1x 4560181  
 2x 663624  
 1x 4179095  
 1x 4179094  
 1x 4515349  
 1x 4542677  
 1x 4256320  
 1x 243224  
 2x 408324  
 1x 4639064  
 1x 4262022

1x 4526983  
 1x 4613418  
 1x 4261301  
 1x 4654328  
 2x 389924  
 1x 383824  
 1x 300526  
 8x 4121966  
 4x 4188534  
 1x 4658977  
 2x 4163334  
 1x 302326  
 2x 4599499  
 1x 306926  
 1x 4569733  
 3x 403226  
 2x 602026  
 1x 383226  
 2x 370326

8x 4121715  
 1x 4567910  
 1x 383526  
 12x 4568644  
 8x 4140670  
 8x 448826  
 2x 292626  
 1x 4124096  
 1x 4262023  
 1x 4517986  
 3x 4649722  
 3x 4649705  
 1x 300423  
 2x 4181139  
 10x 3000023  
 2x 4212411

2x 4587840  
 1x 4648084  
 3x 407923  
 2x 9566  
 2x 368023  
 4x 4143005  
 2x 4514553  
 1x 379523  
 2x 287701  
 15x 302301  
 8x 302201  
 7x 371001  
 9x 366601  
 2x 4243812  
 2x 379501  
 1x 303201  
 2x 447701  
 1x 4120020

2x 307001  
 2x 4538353  
 4x 306901  
 2x 4249563  
 2x 4515364  
 1x 4287153  
 1x 4527947  
 1x 4160857  
 1x 4161326  
 2x 4249506  
 1x 4508408  
 1x 4261470  
 1x 4649224  
 12x 4170457  
 8x 4490141  
 1x 4114319  
 2x 4121921

10x 300521  
 11x 300421  
 3x 4143832  
 1x 301021  
 11x 300921  
 1x 4181138  
 3x 611121  
 2x 4558886  
 4x 330021  
 2x 609121  
 1x 302321  
 2x 371021  
 3x 366621  
 5x 383221  
 1x 4524644  
 2x 241221  
 3x 4140585  
 2x 4178428  
 1x 4547030



4x  
4560179



1x  
4180504



1x  
4180533



2x  
4190219



2x  
486521



1x  
4537986



1x  
4288209



2x  
4540382



6x  
4220516



1x  
4612578



1x  
4612582



1x  
4261690



1x  
4619543



1x  
4549263



1x  
4540606



1x  
4585642



2x  
4659625



1x  
4654613



2x  
4211088



2x  
4558955



6x  
4211128



3x  
4210725



8x  
4567887



2x  
4211064



1x  
4493478



1x  
4288298



4x  
4211063



3x  
4211002



2x  
4210997



1x  
4210967



1x  
4211134



1x  
4211061



3x  
4299022



1x  
4654613



3x  
4603504



1x  
4211053



1x  
4210865



4x  
4271950



2x  
4210844



1x  
4261469



2x  
4260124



1x  
4295253



1x  
4211066



4x  
4210751



2x  
4566927



2x  
4650879



2x  
4187334



7x  
302328



2x  
4518653



2x  
4211480



13x  
4211350



2x  
4211541



2x  
4211436



4x  
4211451



1x  
4535738



1x  
4211413



1x  
4282740



1x  
4261605



1x  
4560183



4x  
4211449



2x  
4650260



2x  
4211525



4x  
4529120



2x  
4263192



2x  
4540203



2x  
4211550



4x  
4211705



4x  
4244362



1x  
3000840



1x  
626440



2x  
4201019



8x  
3005741



11x  
4640026



1x  
4287016



1x  
4599045



8x  
4244366



2x  
4260426



10x  
4113854



2x  
3005743



1x  
4163306



1x  
4198311



1x  
4198311



1x  
4198311



1x  
4198311



1x  
4198311



1x  
4198311

Customer Service  
Kundenservice  
Service Consommateurs  
Servicio Al Consumidor

[www.lego.com/service](http://www.lego.com/service) or dial

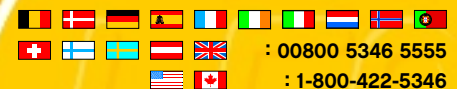

: 00800 5346 5555

: 1-800-422-5346







# WIN!

Go to [www.LEGOsurvey.com/product](http://www.LEGOsurvey.com/product) to fill out a survey for a chance to win a cool LEGO® Product.

No purchase necessary.

Open to all residents where not prohibited.



[www.LEGO.com](http://www.LEGO.com)



## [www.LEGOsurvey.com/product](http://www.LEGOsurvey.com/product)

### GEWINNE!

Nimm an der Umfrage auf [www.LEGOsurvey.com/product](http://www.LEGOsurvey.com/product) teil und hab die Chance ein cooles LEGO® Produkt zu gewinnen!

Die Teilnahme am Gewinnspiel führt zu keinerlei Kaufverpflichtungen. Teilnahme in allen nicht ausgeschlossenen Ländern möglich.

### WIN!

Ga naar [www.LEGOsurvey.com/product](http://www.LEGOsurvey.com/product), vul een enquêteformulier in en maak kans op een cool LEGO® product.

Geen aankoopverplichting.  
Iedereen mag deelnemen, uitgezonderd ingezetenden van landen waar een enquêteverbod geldt.

### GAGNE!

Visite [www.LEGOsurvey.com/product](http://www.LEGOsurvey.com/product) pour répondre à un questionnaire et avoir une chance de gagner un produit LEGO® très cool!

Aucune obligation d'achat.  
Ouvert à tous les résidents des pays autorisés.

### 当てよう!

[www.LEGOsurvey.com/product](http://www.LEGOsurvey.com/product) にアクセスして、アンケートにご記入ください。当選者にはレゴ製品を差し上げます。

お買い上げの必要はありません。  
禁止されていない限り、すべての皆様にご利用いただけます。